



**SAI GLOBAL**  
Distributors of Australian Standards®

# LICENCE

for

Licensee:

Date:

Conditions of use:

[Click here for full conditions of Licence](#)

## WEB LINKS

- Check if this document is current
- Find similar documents
- StandardsWatch (*info and login*)
- Visit our website

International Standards on-line at [www.standards.com.au](http://www.standards.com.au)



**SAI GLOBAL**

STANDARDS  
AUSTRALIA



AS 1170.4—1993

Australian Standard<sup>®</sup>

---

**Minimum design loads on  
structures**

**Part 4: Earthquake loads**

---

This Australian Standard was prepared by Committee BD/6, Loading on Structures. It was approved on behalf of the Council of Standards Australia on 21 April 1993 and published on 16 August 1993.

---

The following interests are represented on Committee BD/6:

Association of Consulting Engineers, Australia  
Association of Consulting Structural Engineers, N.S.W.  
AUBRCC  
Australian Clay Brick Association  
Australian Construction Services—Department of Administrative Services  
Australian Federation of Construction Contractors  
Australian Institute of Steel Construction  
AUSTROADS  
Bureau of Meteorology  
Bureau of Steel Manufacturers of Australia  
CSIRO, Division of Building, Construction and Engineering  
Electricity Supply Association of Australia  
Engineering and Water Supply Department, S.A.  
James Cook University of North Queensland  
Master Builders Construction and Housing Association, Australia  
Monash University  
Public Works Department, N.S.W.  
University of Melbourne  
University of Newcastle

Additional interests participating in preparation of this Standard:

Australian Geological Survey Organization  
Cement and Concrete Association of Australia  
Department of Housing and Construction, S.A.  
Department of Mines and Energy, S.A.  
Department of Resource Industries, Qld.  
Institution of Engineers, Australia  
Insurance Council of Australia  
Phillip Institute of Technology, Vic.  
Steel Reinforcement Institute of Australia  
University of Adelaide  
University of Queensland

---

**Review of Australian Standards.** To keep abreast of progress in industry, Australian Standards are subject to periodic review and are kept up to date by the issue of amendments or new editions as necessary. It is important therefore that Standards users ensure that they are in possession of the latest edition, and any amendments thereto.

Full details of all Australian Standards and related publications will be found in the Standards Australia Catalogue of Publications; this information is supplemented each month by the magazine 'The Australian Standard', which subscribing members receive, and which gives details of new publications, new editions and amendments, and of withdrawn Standards.

Suggestions for improvements to Australian Standards, addressed to the head office of Standards Australia, are welcomed. Notification of any inaccuracy or ambiguity found in an Australian Standard should be made without delay in order that the matter may be investigated and appropriate action taken.

---

*This Standard was issued in draft form for comment as DR 91094..*

Australian Standard®

---

**Minimum design loads on  
structures (known as the  
SAA Loading Code)**

**Part 4: Earthquake loads**

---

First published as part of AS 2121—1979.  
Revised and redesignated in part as AS 1170.4—1993.

Incorporating:  
Amdt 1—1994.

## PREFACE

This Standard was prepared by the Standards Australia Committee for Loading on Structures to supersede [AS 2121—1979](#), *SAA Earthquake Code* and [AS 2121M—1979](#) *Seismic Zone map of Australia*.

This edition incorporates the following major changes to the previous edition:

- (a) The Standard is now in a *limit states format*.
- (b) New earthquake maps of Australia and of each State/Territory, defined in terms of an acceleration coefficient, are included.
- (c) Domestic structures are now included (Section 3).
- (d) [AS 2121—1979](#) contains provisions for earthquake loads and in addition, design and detailing requirements for some of the major structural materials. This Standard contains only loading requirements.

In preparing this Standard, the Committee referred to the documents listed in the Commentary, [AS 1170.4 Supplement 1](#).

Acknowledgment is made of the Australian Geological Survey Organization's copyright of the earthquake acceleration coefficient maps of Australia, States and Territory, and appreciation is recorded for permission to include the maps in this Standard.

© Copyright — STANDARDS AUSTRALIA

Users of Standards are reminded that copyright subsists in all Standards Australia publications and software. Except where the Copyright Act allows and except where provided for below no publications or software produced by Standards Australia may be reproduced, stored in a retrieval system in any form or transmitted by any means without prior permission in writing from Standards Australia. Permission may be conditional on an appropriate royalty payment. Requests for permission and information on commercial software royalties should be directed to the head office of Standards Australia.

Standards Australia will permit up to 10 percent of the technical content pages of a Standard to be copied for use exclusively in-house by purchasers of the Standard without payment of a royalty or advice to Standards Australia.

Standards Australia will also permit the inclusion of its copyright material in computer software programs for no royalty payment provided such programs are used exclusively in-house by the creators of the programs.

Care should be taken to ensure that material used is from the current edition of the Standard and that it is updated whenever the Standard is amended or revised. The number and date of the Standard should therefore be clearly identified.

The use of material in print form or in computer software programs to be used commercially, with or without payment, or in commercial contracts is subject to the payment of a royalty. This policy may be varied by Standards Australia at any time.

# CONTENTS

	<i>Page</i>
FOREWORD .....	5
SECTION 1 SCOPE AND GENERAL	
1.1 SCOPE .....	8
1.2 REFERENCED DOCUMENTS .....	8
1.3 DEFINITIONS .....	8
1.4 NOTATION .....	10
1.5 METHODS OF DETERMINATION OF EARTHQUAKE LOADS .....	12
1.6 EARTHQUAKE LOAD COMBINATIONS .....	12
SECTION 2 GENERAL REQUIREMENTS	
2.1 GENERAL .....	13
2.2 STRUCTURE CLASSIFICATION .....	13
2.3 ACCELERATION COEFFICIENT .....	13
2.4 SITE FACTOR .....	23
2.5 IMPORTANCE FACTOR .....	24
2.6 EARTHQUAKE DESIGN CATEGORY .....	24
2.7 REQUIREMENTS FOR GENERAL STRUCTURES .....	24
2.8 STRUCTURAL SYSTEMS OF BUILDINGS .....	26
2.9 CONFIGURATION .....	27
2.10 DEFLECTION AND DRIFT LIMITS .....	28
SECTION 3 DOMESTIC STRUCTURES	
3.1 GENERAL .....	29
3.2 REQUIREMENTS FOR EARTHQUAKE DESIGN CATEGORIES .....	29
3.3 STRUCTURAL DETAILING REQUIREMENTS FOR DOMESTIC STRUCTURES .....	29
3.4 STATIC ANALYSIS FOR NON-DUCTILE DOMESTIC STRUCTURES OF EARTHQUAKE DESIGN CATEGORY H3 .....	29
3.5 NON-STRUCTURAL COMPONENTS .....	30
SECTION 4 STRUCTURAL DETAILING REQUIREMENTS FOR GENERAL STRUCTURES	
4.1 GENERAL .....	31
4.2 STRUCTURAL DETAILING REQUIREMENTS FOR STRUCTURES OF EARTHQUAKE DESIGN CATEGORY A .....	31
4.3 STRUCTURAL DETAILING REQUIREMENTS FOR STRUCTURES OF EARTHQUAKE DESIGN CATEGORY B .....	31
4.4 STRUCTURAL DETAILING REQUIREMENTS FOR STRUCTURES OF EARTHQUAKE DESIGN CATEGORIES C, D AND E .....	31
SECTION 5 REQUIREMENTS FOR NON-STRUCTURAL COMPONENTS	
5.1 GENERAL REQUIREMENTS .....	33
5.2 REQUIREMENTS FOR ARCHITECTURAL COMPONENTS .....	35
5.3 REQUIREMENTS FOR MECHANICAL AND ELECTRICAL COMPONENTS .....	36
5.4 AMPLIFICATION FACTOR .....	37

SECTION 6	STATIC ANALYSIS	
6.1	GENERAL .....	38
6.2	HORIZONTAL FORCES .....	38
6.3	VERTICAL DISTRIBUTION OF HORIZONTAL EARTHQUAKE FORCES .....	39
6.4	HORIZONTAL SHEAR DISTRIBUTION .....	42
6.5	TORSIONAL EFFECTS .....	42
6.6	STABILITY EFFECTS .....	44
6.7	DRIFT DETERMINATION AND <i>P</i> -DELTA EFFECTS .....	44
6.8	VERTICAL COMPONENT OF GROUND MOTION .....	45
SECTION 7	DYNAMIC ANALYSIS	
7.1	GENERAL .....	46
7.2	EARTHQUAKE ACTIONS .....	46
7.3	MATHEMATICAL MODEL .....	47
7.4	ANALYSIS PROCEDURES .....	47
7.5	STABILITY EFFECTS .....	48
7.6	DRIFT DETERMINATION AND <i>P</i> -DELTA EFFECTS .....	48
SECTION 8	STRUCTURAL ALTERATIONS .....	49
APPENDICES		
A	STRUCTURE CLASSIFICATION .....	50
B	STRUCTURAL SYSTEM .....	55
C	DOMESTIC STRUCTURES .....	56
D	TYPES OF DYNAMIC ANALYSIS .....	58
E	STRUCTURAL ALTERATIONS .....	60

## FOREWORD

The purpose of designing structures for earthquake loads is to—

- (a) minimize the risk of loss of life from structure collapse or damage in the event of an earthquake;
- (b) improve the expected performance of structures; and
- (c) improve the capability of structures that are essential to post-earthquake recovery to function during and after an earthquake, and to minimize the risk of damage to hazardous facilities.

The design of structures to this Standard does not necessarily prevent structural and non-structural damage in the event of an earthquake. The provisions provide the minimum criteria considered to be prudent for the protection of life by minimizing the likelihood of collapse of the structures.

The ground motions specified in this Standard are for the 'design earthquake' based on an estimated 90% probability of these ground motions not being exceeded in a 50-year period.

The detailing requirements specified in this Standard are of a general nature related specifically to earthquake resistant design. Specific detailing appropriate for each material (concrete, steel, masonry, timber, etc.) will be found in the relevant material Standards.

A flow chart showing the procedure for determining whether a structure needs to be designed for earthquake loads and, if required, the determination of design earthquake loads is shown in Figures 1(a) and 1(b).



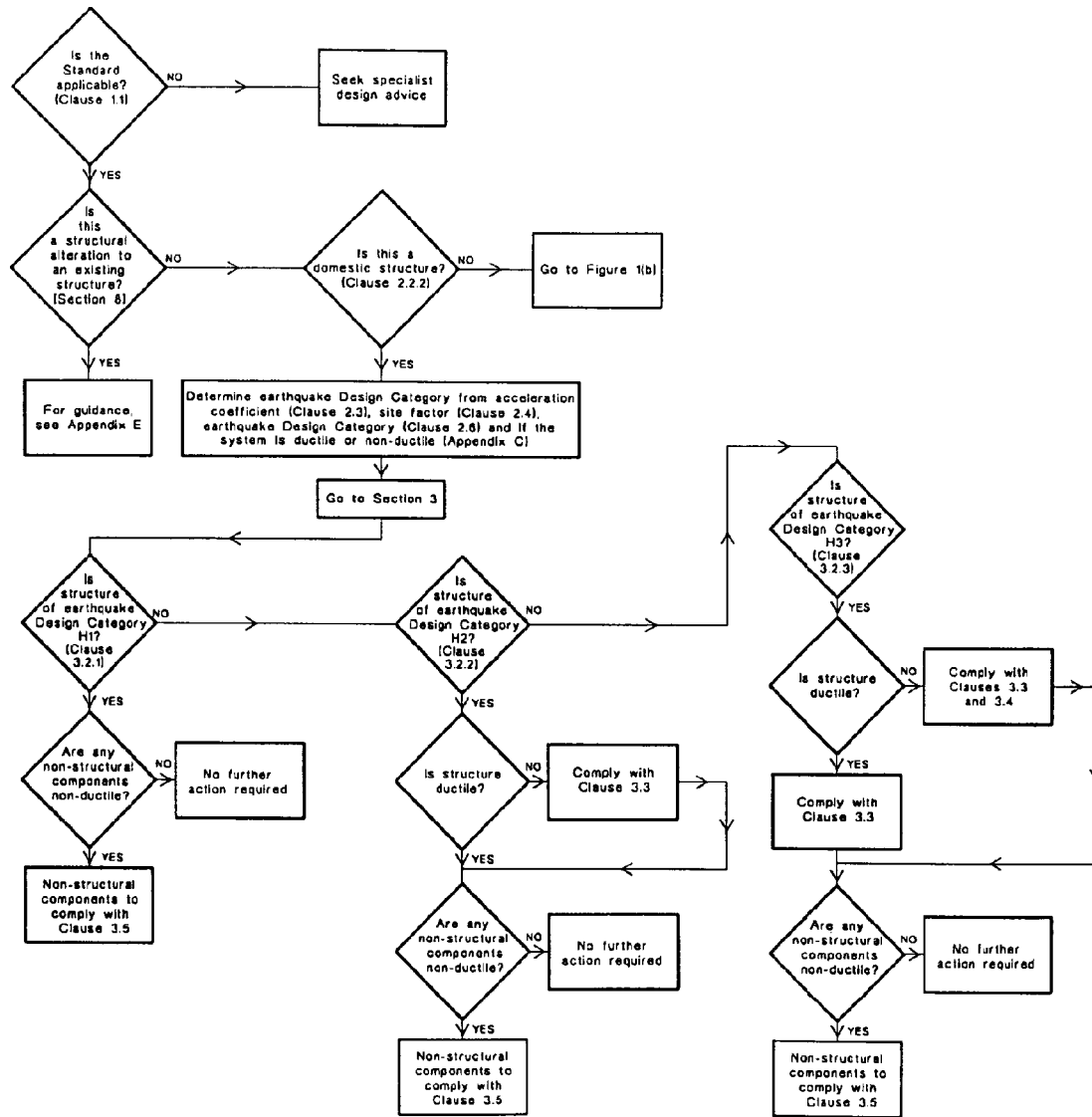

(a) Domestic structures

FIGURE 1 (in part) FLOWCHART FOR DETERMINATION OF EARTHQUAKE LOADS

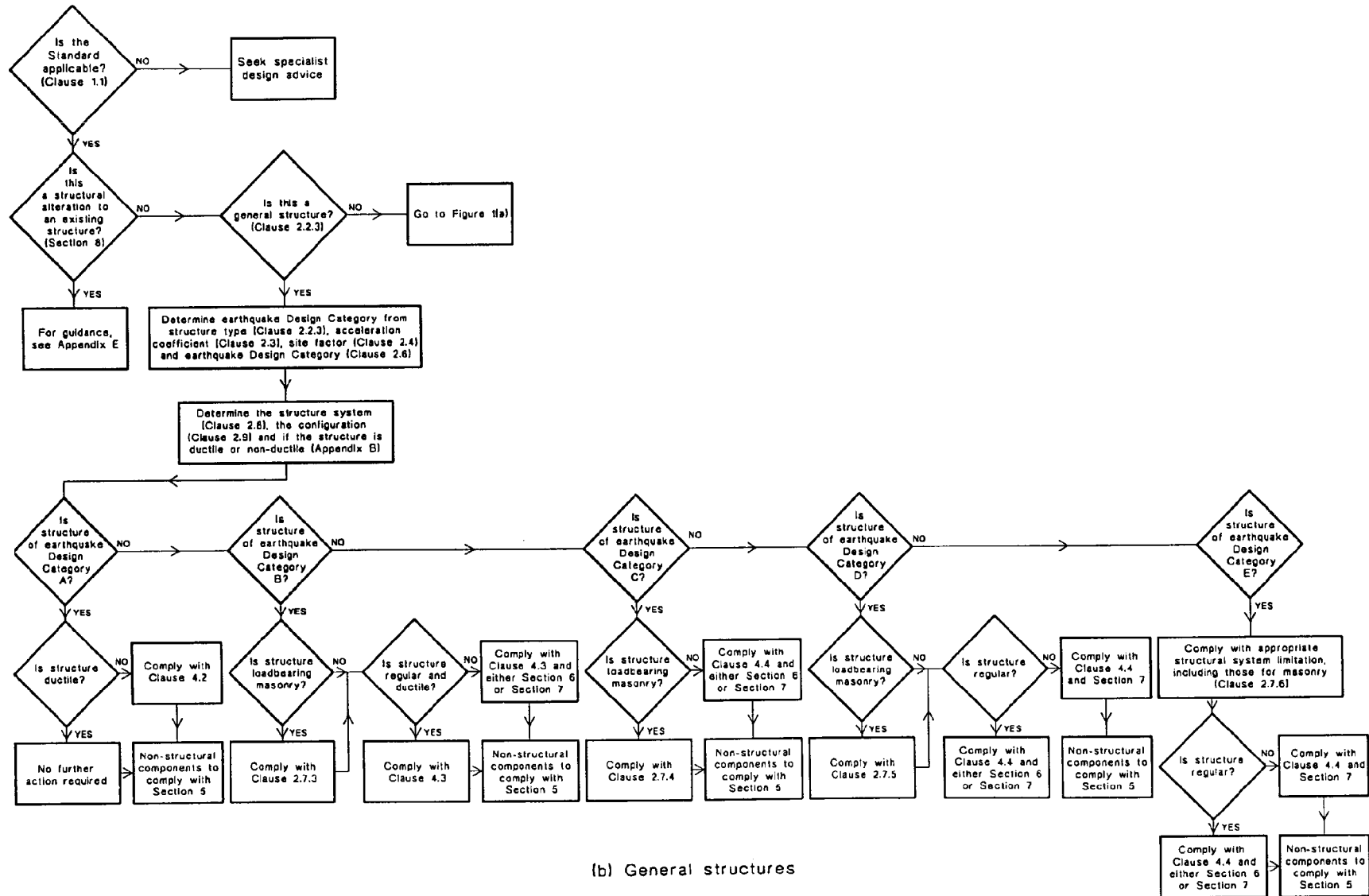

(b) General structures

FIGURE 1 (in part) FLOWCHART FOR DETERMINATION OF EARTHQUAKE LOADS

## STANDARDS AUSTRALIA

---

 Australian Standard

 Minimum design loads on structures
 

---

 Part 4: Earthquake loads
 

---

## SECTION 1 SCOPE AND GENERAL

**1.1 SCOPE** This Standard sets out data and procedures for determining minimum earthquake loads on structures and their components. It also sets out minimum detailing requirements for structures. It does not consider related phenomena such as settlement, slides, subsidence, liquefaction or faulting in the immediate vicinity of a structure.

This Standard is intended to apply to structures, particularly buildings, non-building structures, fixings and non-structural components including building services and architectural elements.

Special structures including nuclear reactors, dams, transmission towers, bridges, piers and wharves may require special considerations, and are not covered by this Standard.

NOTE: The date of application of this Standard on a mandatory basis is a matter for the relevant regulatory authorities. With the publication of this Standard, [AS 2121—1979](#) becomes an available superseded Standard and will be withdrawn following substantial regulatory implementation of this edition, or within two years of publication of this edition, whichever is the earlier.

**1.2 REFERENCED DOCUMENTS** The following documents are referred to in this Standard:

## AS

1170 SAA Loading Code

[1170.1](#) Part 1: Dead and live loads and load combinations[1684](#) National Timber Framing Code[1720](#) SAA Timber Structures Code[1726](#) SAA Site Investigation Code[3600](#) Concrete structures[3700](#) SAA Masonry Code[4100](#) Steel structures

## NZS

3604 Code of Practice for Light Timber Frame Buildings

**1.3 DEFINITIONS** For the purpose of this Standard, the definitions below apply.

**1.3.1 Acceleration coefficient**—an index related to the expected severity of earthquake ground motion.

**1.3.2 Base**—see definition of structural base (Clause 1.3.36).

**1.3.3 Base shear**—the total horizontal earthquake shear force ( $V$ ) at the base of the structure.

**1.3.4 Bearing wall system**—a structural system with loadbearing walls providing support for all or most of the vertical loads and shear walls or braced frames providing the horizontal earthquake resistance.

**1.3.5 Braced frame**—an essentially vertical truss, or its equivalent, designed to resist horizontal earthquake forces. Truss members are subjected primarily to axial forces.

**1.3.6 Building frame system**—a structural system in which an essentially complete space frame supports the vertical loads and shear walls or braced frames provide the horizontal earthquake resistance.

**1.3.7 Concentric braced frame**—a braced frame in which the members are subjected primarily to axial forces.

**1.3.8 Diaphragm**—a horizontal or nearly horizontal system, including a horizontal bracing system, acting to transmit horizontal forces to the vertical elements resisting earthquake forces.

**1.3.9 Dual system**—a structural system in which an essentially complete space frame provides support for the vertical loads and at least a quarter of the prescribed horizontal earthquake forces. The total horizontal earthquake resistance is provided by the combination of the moment frame, shear walls or braced frames, in proportion to their relative rigidities.

**1.3.10 Ductility**—the ability of the structure or element to undergo repeated and reversing inelastic deflections beyond the point of first yield while maintaining a substantial proportion of its initial load-carrying capacity.

**1.3.11 Drift**—see definition of storey drift (Clause 1.3.30).

**1.3.12 Earthquake design category**—a category assigned to a structure based on its structure classification, acceleration coefficient and site factor for the site.

**1.3.13 Earthquake resisting system**—that part of the structural system which is considered in the design to provide resistance to the earthquake forces.

**1.3.14 Eccentric braced frame**—a braced frame where at least one end of each brace intersects a beam at a location away from the column-girder joint and which complies with the requirements of AS 4100.

**1.3.15 Hazardous facility**—a structure which stores hazardous material.

**1.3.16 Horizontal bracing system**—a horizontal or nearly horizontal truss system that serves the same function as a diaphragm.

**1.3.17 Intermediate moment resisting frame (IMRF)**—a concrete or steel space frame designed in accordance with AS 3600 or AS 4100, respectively, in which members and joints are capable of resisting forces by flexure as well as axial forces along the axis of the members, including specific ductility requirements (see Appendix B).

**1.3.18 Loadbearing wall**—a wall providing support for vertical loads in addition to its own weight.

**1.3.19 Moment resisting frame system**—a structural system in which an essentially complete space frame supports the vertical loads and the total prescribed horizontal earthquake forces by the flexural action of members.

**1.3.20 Non-loadbearing wall**—a wall which does not provide support for vertical loads other than its own weight.

**1.3.21 Ordinary moment resisting frame (OMRF)**—a space frame in which members and joints are capable of resisting forces by flexure as well as axial forces along the axis of the members without any special ductility requirements (see Appendix B).

**1.3.22 Orthogonal effect**—the effect on the structure due to earthquake motions acting simultaneously in directions other than parallel to the direction of resistance under consideration.

**1.3.23 P-delta effect**—the secondary effect on shears and moments of frame members induced by the vertical loads acting on the horizontally-displaced building frame.

**1.3.24 Shear wall**—a wall designed to resist horizontal earthquake forces acting in the plane of the wall. A shear wall can be either loadbearing or non-loadbearing.

**1.3.25 Soft storey**—one in which the horizontal stiffness of the storey is less than 70% of that in the storey above or less than 80% of the average stiffness of the three storeys above.

**1.3.26 Space frame**—a three dimensional structural system composed of interconnected members, other than loadbearing walls, which is capable of supporting vertical loads and may also provide horizontal resistance to earthquake forces.

**1.3.27 Special moment resisting frame (SMRF)**—a concrete or steel space frame designed in accordance with AS 3600 or AS 4100, respectively, in which members and joints are capable of resisting forces by flexure as well as axial forces along the axis of the members with special ductility requirements (see Appendix B).

**1.3.28 Static eccentricity**—the distance from the shear centre to the centre of mass at the level considered, measured perpendicular to the direction of loading.

**1.3.29 Storey**—the space between levels including the space between the structural base and the level above. Storey  $x$  is the storey below level  $x$  (see Figure 6.3).

**1.3.30 Storey drift**—the displacement of one level relative to the level above or below.

**1.3.31 Storey drift ratio**—the storey drift divided by the storey height.

**1.3.32 Storey height**—the distance from floor level to floor level.

**1.3.33 Storey shear**—the summation of all the design horizontal forces acting on the levels above the storey under consideration (see Figure 6.3).

**1.3.34 Storey strength**—the total horizontal load capacity of all earthquake resisting elements sharing the storey shear for the direction under consideration.

**1.3.35 Structure**—an assemblage of members designed to support gravity loads and resist horizontal forces and may be either a building structure or a non-building structure.

**1.3.36 Structural base**—the level at which the earthquake ground motions are considered to be imparted to the structure or the level at which the structure as a dynamic vibrator is supported (see Figure 6.3).

**1.3.37 Structure classification**—a classification assigned to a structure based on its use.

**1.3.38 Vertical load-carrying frame**—a space frame designed to carry all vertical loads.

**1.3.39 Weak storey**—one in which the storey strength is less than 80% of that in the storey above.

**1.4 NOTATION** Symbols used in this Standard are listed below.

The dimensional units for length, force and stress in all expressions or equations are to be taken as millimetres (mm), newtons (N) and megapascals (MPa), respectively, unless specified otherwise.

$A_1, A_2$  = dynamic eccentricity factor

$a$  = acceleration coefficient

$a_c$  = attachment amplification factor

$a_x$  = height amplification factor at level  $x$

$b$	= maximum dimension of the structure at level $x$ , measured perpendicular to the horizontal earthquake shear force direction at the level under consideration
$C$	= earthquake design coefficient
$C_{c1}$	= earthquake coefficient for architectural components
$C_{c2}$	= earthquake coefficient for mechanical and electrical components
$C_{vx}$	= earthquake design coefficient for vertical distribution of earthquake forces
$e_{d1}$	= primary design eccentricity
$e_{d2}$	= secondary design eccentricity
$e_s$	= static eccentricity
$F_{eq}$	= earthquake load calculated in accordance with this Standard
$F_i$	= horizontal earthquake force applied at level $i$
$F_n$	= horizontal earthquake force applied at level $n$
$F_p$	= horizontal earthquake force applied to a component of a structure or equipment at its centre of gravity
$F_x$	= horizontal earthquake force applied at level $x$
$G$	= dead load (see <a href="#">AS 1170.1</a> )
$G^c$	= portion of the dead load tending to cause instability
$G_c$	= weight of a component of a structure or equipment
$G_g$	= gravity load
$G_g^R$	= portion of the gravity load tending to resist instability
$G_{gi}$	= portion of gravity load ( $G_g$ ) located or applied at level $i$
$G_{gx}$	= portion of gravity load ( $G_g$ ) located or applied at level $x$
$g$	= gravitational constant ( $9.81 \text{ m/s}^2$ )
$h_n$	= total height of the structure above the structural base
$h_i$	= height above the structural base of the structure to level $i$
$h_{sx}$	= height of storey $x$
$h_x$	= height above the structural base of the structure to level $x$ ; <i>or</i> height above the structural base of the structure at which a component is attached
$I$	= importance factor
$K$	= stiffness of the attachment in the relevant direction
$K_d$	= deflection amplification factor
$k$	= exponent related to structure period
$L$	= total horizontal dimension of the structure, perpendicular to the direction of the earthquake action being considered
$M$	= overturning moment
$m$	= stability coefficient
$n$	= number of levels in structure
$P_x$	= total vertical design load at storey $x$
$Q$	= live load (see <a href="#">AS 1170.1</a> )
$Q^c$	= portion of the live load tending to cause instability

$R_f$	= structural response factor
$S$	= site factor
$T$	= structure period
$T_c$	= period of vibration of a component and its attachment
$V$	= total horizontal earthquake base shear force
$V_x$	= horizontal earthquake shear force at storey $x$
$\Delta$	= design storey drift
$\delta_x$	= deflection of the storey
$\delta_{xe}$	= deflection determined by an elastic analysis
$\psi_c$	= live load combination factor used in assessing the design load for strength and stability limit states

**1.5 METHODS OF DETERMINATION OF EARTHQUAKE LOADS** The earthquake loads shall be determined by—

- applying the requirements of this Standard; or
- using reliable data and references in a manner compatible with the requirements of this Standard together with information on local conditions.

## 1.6 EARTHQUAKE LOAD COMBINATIONS

**1.6.1 Limit states design** For limit state design, the following load combinations involving earthquake shall be taken into account. These load combinations shall take precedence over the load combinations for earthquake given in AS 1170.1 for the corresponding limit states.

- Strength limit state* The earthquake load combination for strength limit state design shall be as follows:

$$(i) \quad G + \psi_c Q + F_{eq} \quad \dots \quad 1.6.1(1)$$

$$(ii) \quad 0.8(G + \psi_c Q) + F_{eq} \quad \dots \quad 1.6.1(2)$$

where

$G$  = dead load (see AS 1170.1)

$\psi_c$  = live load combination factor used in assessing the design load for strength and stability limit states (see AS 1170.1)

$Q$  = live load (see AS 1170.1)

$F_{eq}$  = earthquake load calculated in accordance with this Standard

- Stability limit state* The earthquake load combination for stability limit state design shall be as follows:

$$1.25G^c + \psi_c Q^c + F_{eq} \leq 0.8(G + \psi_c Q)^R + \phi R \quad \dots \quad 1.6.1(3)$$

where

$G^c$  = portion of the dead load tending to cause instability

$Q^c$  = portion of the live load tending to cause instability

$(G + \psi_c Q)^R$  = portion of the dead load and factored live load tending to resist instability

$\phi R$  = design capacity of the structural component (see AS 1170.1)

For the calculation of the earthquake load effects that cause instability, see Clause 6.6.

**1.6.2 Permissible stress design** For permissible stress design, the earthquake load calculated in accordance with this Standard shall be divided by 1.4 to give equivalent working earthquake load.

## SECTION 2 GENERAL REQUIREMENTS

**2.1 GENERAL** Not all structures are required to be designed for earthquake loads. If required by this Standard, earthquake loads shall be determined by either—

- (a) static analysis; or
- (b) dynamic analysis.

The method of analysis depends on the earthquake design category, the structure configuration and the ductility of the structure. The earthquake design category depends on—

- (i) the structure classification (see Clause 2.2);
- (ii) the acceleration coefficient (see Clause 2.3); and
- (iii) the site factor (see Clause 2.4).

### 2.2 STRUCTURE CLASSIFICATION

**2.2.1 General** For the purpose of earthquake design, structures shall be classified as either domestic structures or general structures.

**2.2.2 Domestic structures** For the purpose of this Standard, domestic structures are detached single dwellings, terrace houses, townhouses and the like with the following limitations:

- (a) The distance from ground level to the underside of eaves shall not exceed 6.0 m; from ground level to the highest point of the roof, neglecting chimneys, shall not exceed 8.5 m; and the height of each storey at external walls shall not exceed 2.7 m (see Figure 2.2.2(a)).

NOTE: For earthquake design, the height of each storey at external walls may be increased to 3.2 m.

- (b) The width, including roofed verandahs but excluding eaves, shall not exceed 16.0 m, and the total length ( $L_1 + L_2$ ) shall not exceed 10 times the width (see Figure 2.2.2(b)).

**2.2.3 General structures** General structures include all structures other than those specified in Clause 2.2.2 and shall be further classified into structure types as follows:

- (a) *Type III* Structures include buildings that are essential to post-earthquake recovery or associated with hazardous facilities.
- (b) *Type II* Structures include buildings that are designed to contain a large number of people, or people of restricted or impaired mobility.
- (c) *Type I* Structures include buildings not of Type II or Type III.

NOTE: For examples of structure classification, see Appendix A.

**2.3 ACCELERATION COEFFICIENT** The acceleration coefficient ( $a$ ) depends on the geographic location of the structure (see Figure 2.3(a)) and shall be determined from Table 2.3 in the first instance. If the acceleration coefficient for the location required is not given in Table 2.3, it shall be determined from Figures 2.3(b) to 2.3(g).

Linear interpolation between contours shown in Figures 2.3(b) to 2.3(g) is permitted.



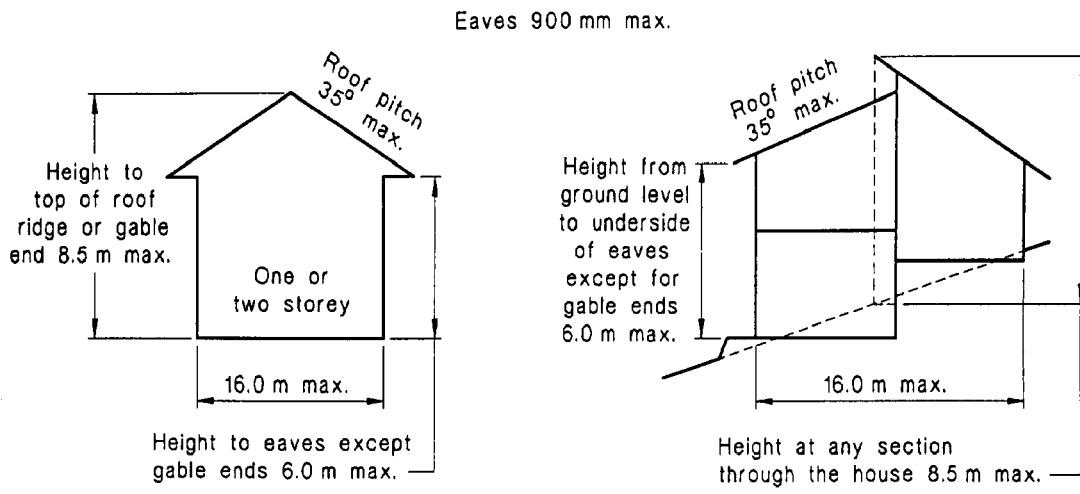

(a) Sections

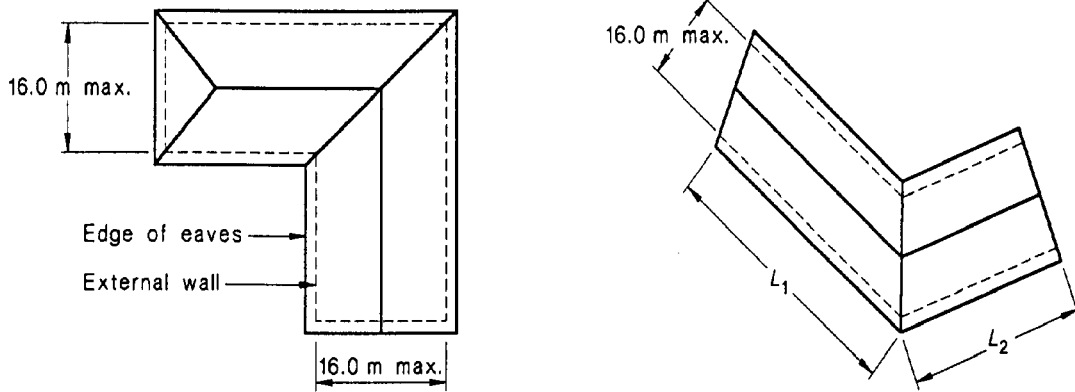

(b) Top views

FIGURE 2.2.2 GEOMETRY

**TABLE 2.3**  
**ACCELERATION COEFFICIENT**  
**FOR MAJOR CENTRES**

Major centres	Acceleration coefficient ( <i>a</i> )
Adelaide	0.10
Albury/Wodonga	0.08
Ballarat	0.08
Bendigo	0.09
Brisbane	0.06
Cairns	0.06
Canberra	0.08
Darwin	0.08
Geelong	0.10
Gold Coast/ Tweed Heads	0.06
Hobart	0.05
Latrobe Valley	0.10
Launceston	0.06
Melbourne	0.08
Newcastle	0.11
Perth	0.09
Rockhampton	0.08
Sydney	0.08
Toowoomba	0.06
Townsville	0.07
Wollongong	0.08

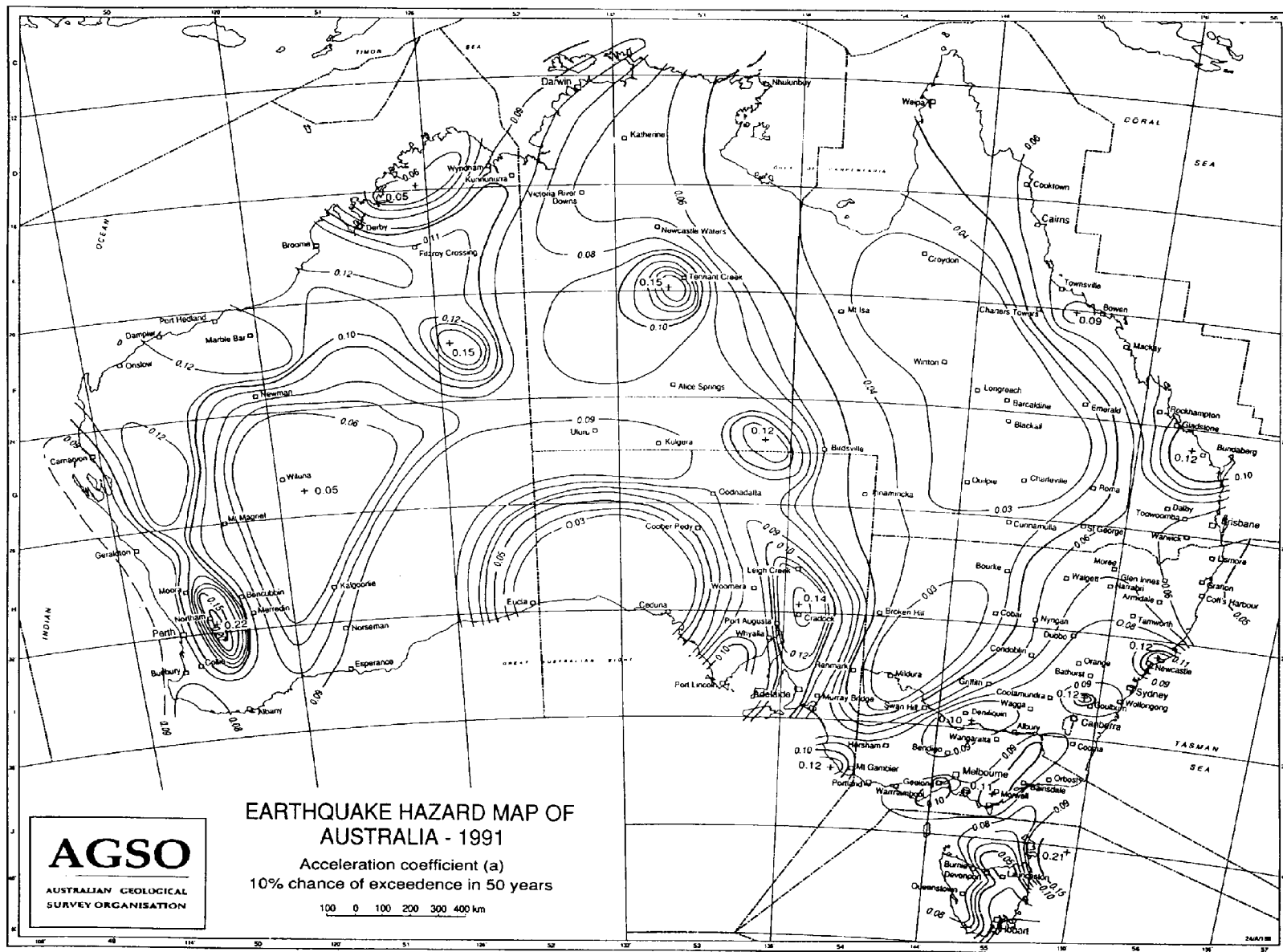

FIGURE 2.3(a) ACCELERATION COEFFICIENT MAP OF AUSTRALIA

COPYRIGHT

Licensed to paul goobold on 18 Aug 2005. 1 user personal user licence only. Storage, distribution or use on network prohibited.

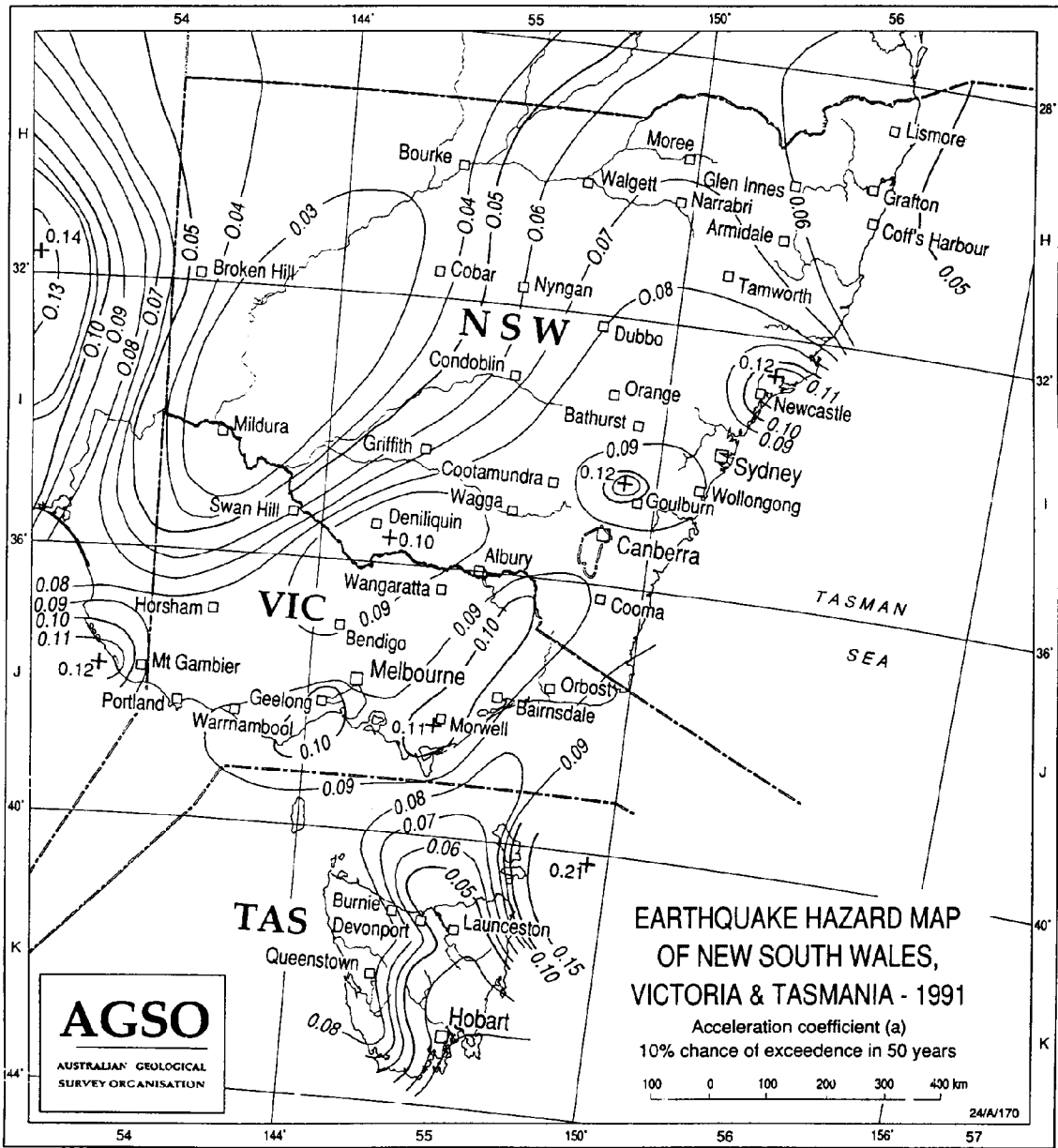

FIGURE 2.3(b) ACCELERATION COEFFICIENT MAP OF NEW SOUTH WALES, VICTORIA AND TASMANIA

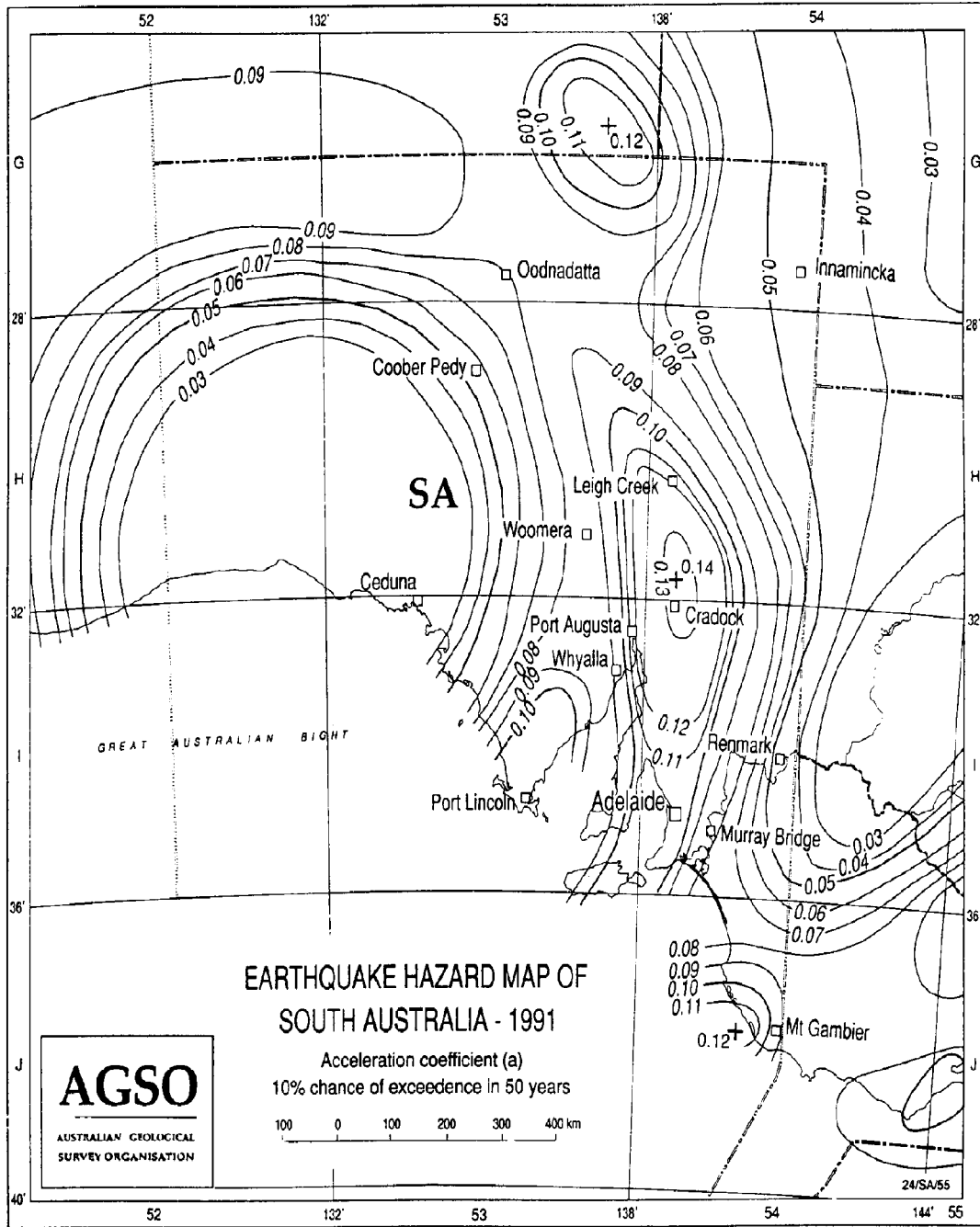

FIGURE 2.3(c) ACCELERATION COEFFICIENT MAP OF SOUTH AUSTRALIA

Licensed to paul godbold on 18 Aug 2005. 1 user personal user licence only. Storage, distribution or use on network prohibited.

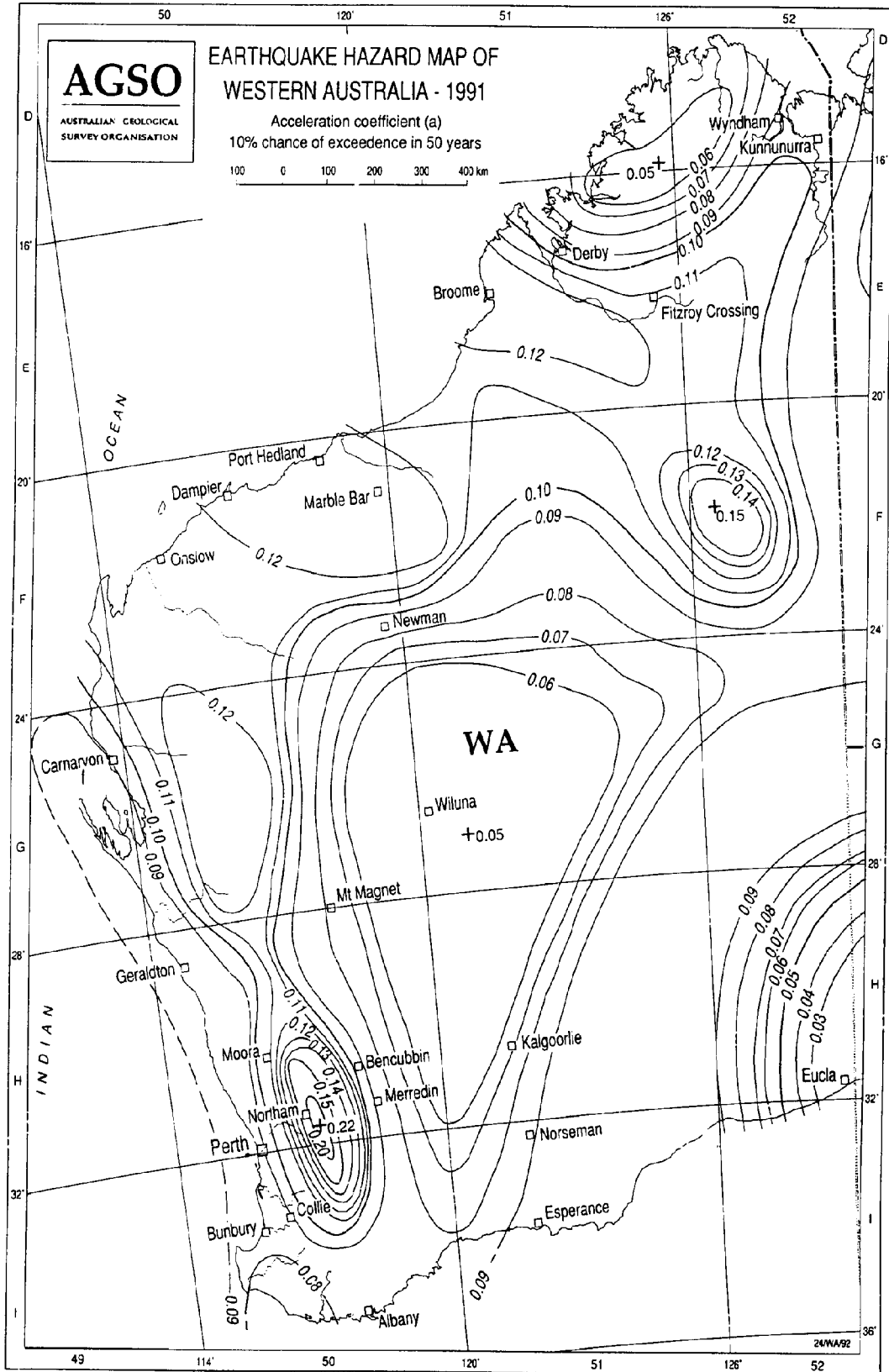

FIGURE 2.3(d) ACCELERATION COEFFICIENT MAP OF WESTERN AUSTRALIA

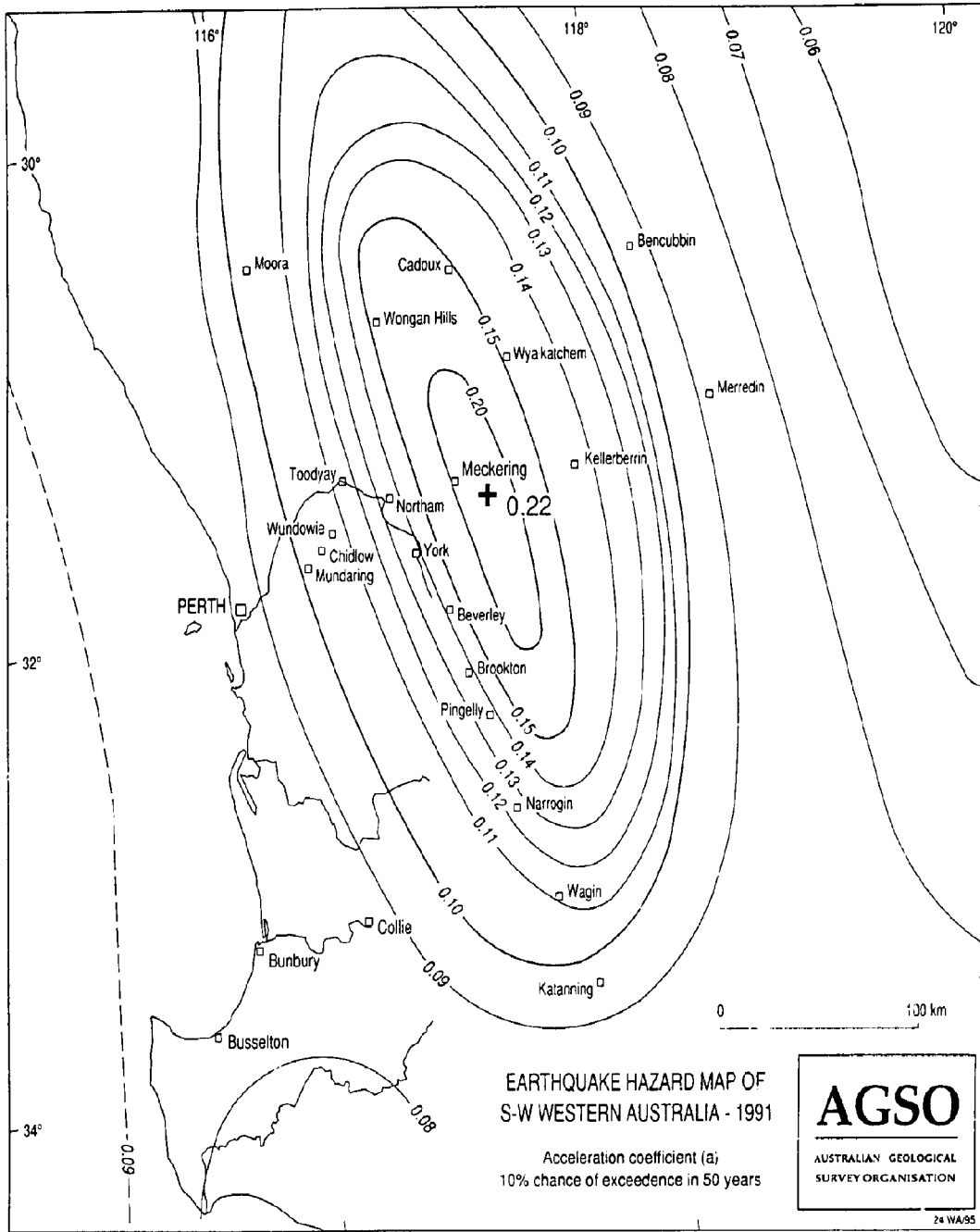

FIGURE 2.3(e) ACCELERATION COEFFICIENT MAP OF SOUTH-WEST OF WESTERN AUSTRALIA

Licensed to paul godbold on 18 Aug 2005. 1 user personal user licence only. Storage, distribution or use on network prohibited.

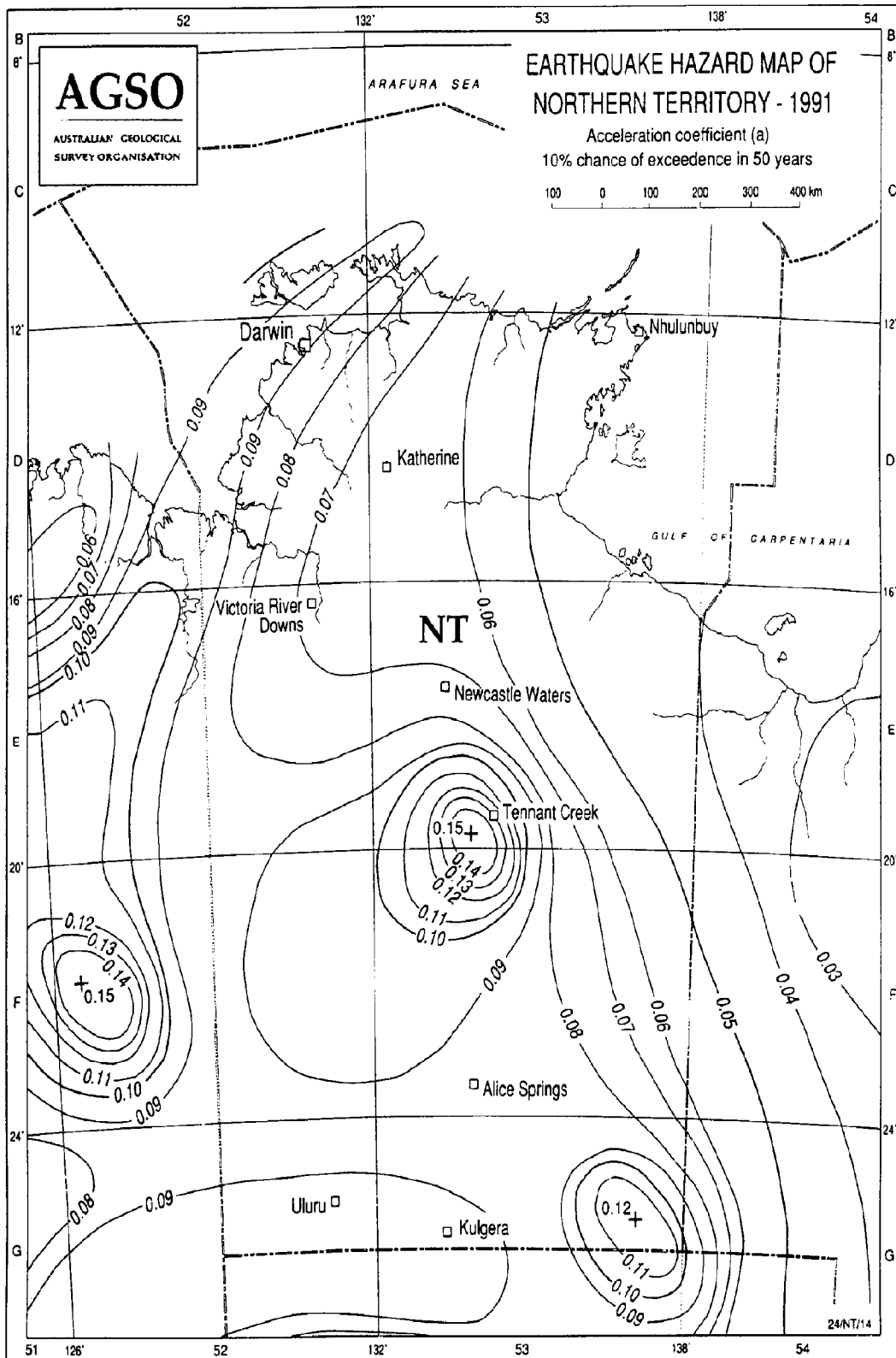

FIGURE 2.3(f) ACCELERATION COEFFICIENT MAP OF NORTHERN TERRITORY



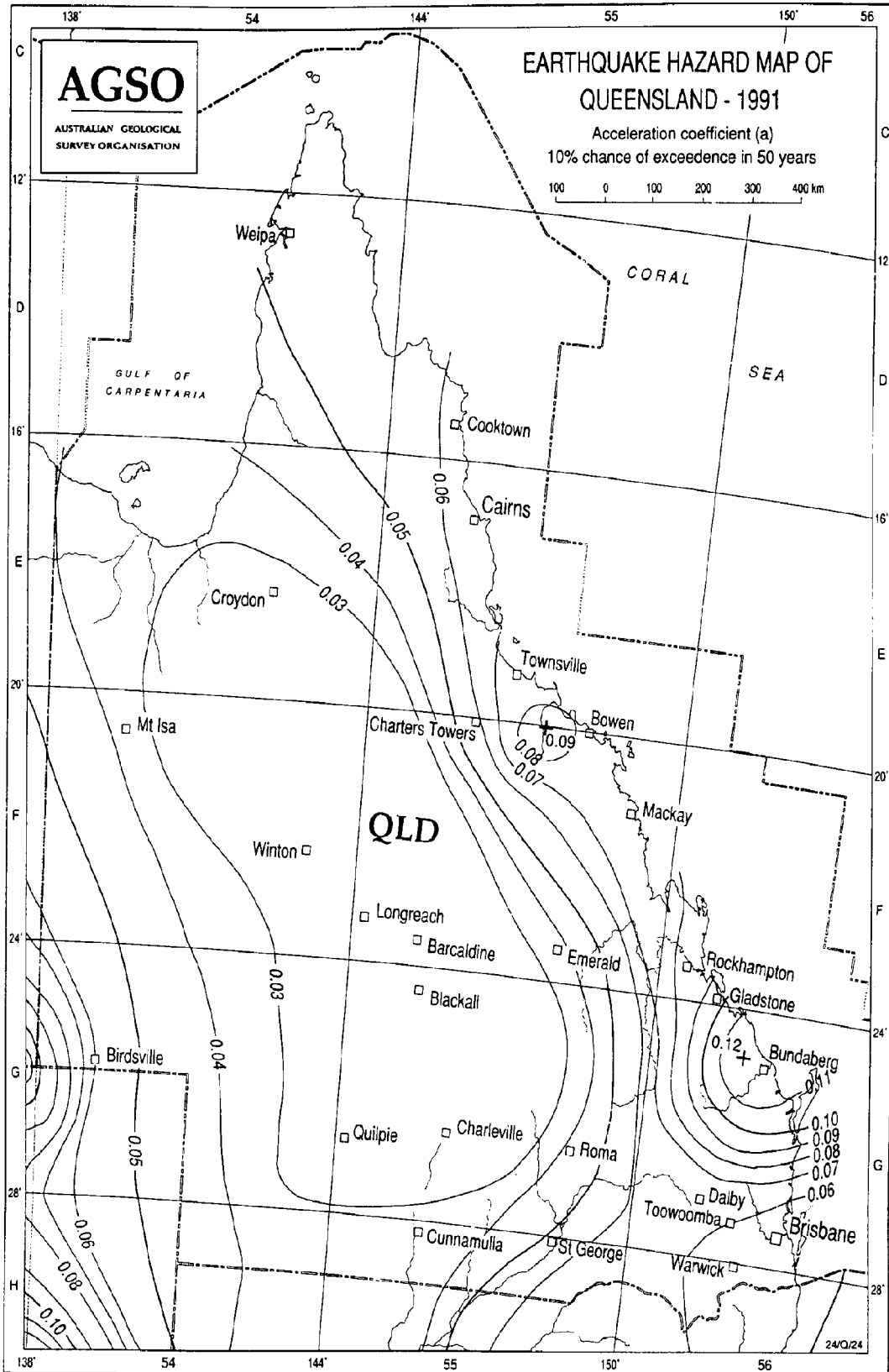

FIGURE 2.3(g) ACCELERATION COEFFICIENT MAP OF QUEENSLAND

**2.4 SITE FACTOR** The site factor ( $S$ ) shall be as given in Table 2.4(a) or Table 2.4(b) for the appropriate soil profile. The soil profile shall be established from substantiated geotechnical data and classified in accordance with AS 1726.

Interpolation for soil profiles in between those given in Tables 2.4(a) and 2.4(b) is permitted.

**TABLE 2.4(a)**  
**SITE FACTORS FOR GENERAL STRUCTURES**

Soil profile	Site factor ( $S$ )
A profile of rock materials with rock strength Class L (low) or better	0.67
A soil profile with either: (a) rock materials Class EL (extreme low) or VL (very low) characterized by shear wave velocities greater than 760 m/s; or (b) not more than 30 m of: medium dense to very dense coarse sands and gravels; firm, stiff or hard clays; or controlled fill	1.0
A soil profile with more than 30 m of: medium dense to very dense coarse sands and gravels; firm, stiff or hard clays; or controlled fill	1.25
A soil profile with a total depth of 20 m or more <i>and</i> containing 6 to 12 m of: very soft to soft clays; very loose or loose sands; silts; or uncontrolled fill	1.5
A soil profile with more than 12 m of: very soft to soft clays; very loose or loose sands; silts; or uncontrolled fill characterized by shear wave velocities less than 150 m/s	2.0

**TABLE 2.4(b)**  
**SITE FACTORS FOR DOMESTIC STRUCTURES**

Soil Profile	Site factor ( $S$ )
Normal soil: any soil profile other than soft	1.0
Soft soil: any soil profile with more than 5 m of: soft clay; loose sand; silt; or uncontrolled fill	2.0

NOTES to Tables 2.4(a) and 2.4(b):

- 1 For the purposes of this Standard, it is not intended that a detailed site investigation be carried out for any structure to determine a soil profile over large depths. Most major centres and regional areas have basic information available on the likely strata which should be used to assess the site factor ( $S$ ).
- 2 Small variations such as isolated layers within the overall profile not exceeding 2 m average depth or changes at or near the surface not exceeding 3 m average depth need not be considered.

- 3 The soil profile considered in determining the site factor should be the soil on which the footings bear or in which pile caps are embedded, and all underlying soil materials.
- 4 Rock strengths Class L , Class EL and Class VL are defined in AS 1726.
- 5 Where the soil profile is not given in the Table, advice from appropriate geotechnical experts should be obtained to establish a suitable site factor ( $S$ ).
- 6 In locations where the soil profiles are not known, a site factor ( $S$ ) equal to 1.5 should be used for general structures and 1.0 for domestic structures. A site factor ( $S$ ) of 2.0 need not be assumed unless it can be determined that such a soil profile may be present or is established by geotechnical data.

**2.5 IMPORTANCE FACTOR** The importance factor ( $I$ ) shall be as given in Table 2.5.

**TABLE 2.5**  
**IMPORTANCE FACTOR**

Structure Type	Importance factor ( $I$ )
III	1.25
II and I	1.00

**2.6 EARTHQUAKE DESIGN CATEGORY** The earthquake Design Category shall be as given in Table 2.6 for the appropriate value of the product of acceleration coefficient and site factor ( $aS$ ) and the structure classification.

**TABLE 2.6**  
**EARTHQUAKE DESIGN CATEGORY**

Product of acceleration coefficient and site factor ( $aS$ )	Design Category			
	Structure classification			
	Domestic structures	General structures		
		Type III	Type II	Type I
$aS \geq 0.2$	H3	E	D	C
$0.1 \leq aS < 0.2$	H2	D	C	B
$aS < 0.1$	H1	C	B	A

Requirements for earthquake Design Categories A to E are specified in Clause 2.7 and for H1 to H3 in Section 3.

## 2.7 REQUIREMENTS FOR GENERAL STRUCTURES

**2.7.1 General** In addition to the requirements of this Clause and Section 4, specific requirements for non-structural components, i.e. architectural, mechanical and electrical components, are set out in Section 5.

### NOTES:

- 1 Prior to using this Clause, establish the structural system of the building, whether the structure is regular or irregular and whether it is ductile or non-ductile.
- 2 For structural systems of buildings, see Clause 2.8.
- 3 For regular and irregular structures, see Clause 2.9.
- 4 For ductile and non-ductile structures, see Paragraph B1 of Appendix B.

**2.7.2 General structures of earthquake Design Category A** Regular and irregular ductile structures of earthquake Design Category A need not be analyzed for earthquake forces, nor are there any structural detailing requirements for earthquake resistance.

Regular and irregular non-ductile structures of earthquake Design Category A need not be analyzed for earthquake forces but shall be detailed in accordance with Clause 4.2.

**2.7.3 General structures of earthquake Design Category B** Regular ductile structures of earthquake Design Category B need not be analyzed for earthquake forces.

Non-ductile structures and irregular ductile structures of earthquake Design Category B shall be analyzed either by static analysis in accordance with Section 6, or by dynamic analysis in accordance with Section 7.

Detailing requirements for structures of earthquake Design Category B shall be in accordance with Clause 4.3.

For loadbearing masonry components, including elements that resist predominantly horizontal forces, the following restrictions apply:

- (a) For regular structures of one to four storeys, unreinforced masonry is acceptable provided the design complies with Section 6 or 7 as appropriate.
- (b) For irregular structures of one to three storeys, unreinforced masonry is acceptable provided the design complies with Section 6 or 7 as appropriate.
- (c) For structures with more storeys than specified in Items (a) and (b), reinforced masonry, reinforced concrete shear walls or braced frames shall be used and shall comply with Section 6 or 7 as appropriate, except that the use of some unreinforced masonry is permitted provided that the reinforced masonry, reinforced concrete shear walls or braced frames are capable of resisting the earthquake forces and that satisfactory structural behaviour of the whole structure is demonstrated.

**2.7.4 General structures of earthquake Design Category C** Regular and irregular structures of earthquake Design Category C shall be analyzed by static analysis in accordance with Section 6, or by dynamic analysis in accordance with Section 7.

Detailing requirements for structures of earthquake Design Category C shall be in accordance with Clause 4.4.

For loadbearing masonry components, including elements that resist predominantly horizontal forces, the following restrictions apply:

- (a) For structures of one to three storeys, unreinforced masonry is acceptable provided the design complies with Section 6 or 7 as appropriate.
- (b) For structures with more storeys than specified in Item (a), reinforced masonry, reinforced concrete shear walls or braced frames shall be used and shall comply with Section 6 or 7 as appropriate, except that the use of some unreinforced masonry is permitted provided that the reinforced masonry, reinforced concrete shear walls or braced frames are capable of resisting the earthquake forces and that satisfactory structural behaviour of the whole structure is demonstrated.

**2.7.5 General structures of earthquake Design Category D** Regular structures of earthquake Design Category D shall be analyzed by static analysis in accordance with Section 6, or by dynamic analysis in accordance with Section 7.

Irregular structures of earthquake Design Category D shall be analyzed by dynamic analysis in accordance with Section 7.

In both regular and irregular structures of earthquake Design Category D, vertical earthquake effects (see Clause 6.8) shall be considered for critical components, such as horizontal cantilevers and horizontal prestressed members.

Detailing requirements for structures of earthquake Design Category D shall be in accordance with Clause 4.4.

For loadbearing masonry components, including elements that resist predominantly horizontal forces, the following restrictions apply:

- (a) For structures of one or two storeys, unreinforced masonry is acceptable provided the design complies with Section 6 or 7 as appropriate.

- (b) For structures with more storeys than specified in Item (a), reinforced masonry, reinforced concrete shear walls or braced frames shall be used and shall comply with Section 6 or 7 as appropriate, except that the use of some unreinforced masonry is permitted provided that the reinforced masonry, reinforced concrete shear walls or braced frames are capable of resisting the earthquake forces and that satisfactory structural behaviour of the whole structure is demonstrated.

**2.7.6 General structures of earthquake Design Category E** Structures of earthquake Design Category E shall be designed with the following limitations on the structural systems:

- (a) Bearing wall system with a structure height limited to 50 m.  
 (b) Building frame system with a structure height limited to 70 m.  
 (c) Moment resisting frame and dual system. A moment resisting frame system with a structure height over 30 m shall have special moment resisting frames (SMRFs) continued down to the footings.

Regular structures of earthquake Design Category E shall be analyzed by static analysis in accordance with Section 6, or by dynamic analysis in accordance with Section 7.

Irregular structures of earthquake Design Category E shall be analyzed by dynamic analysis in accordance with Section 7.

In both regular and irregular structures of earthquake Design Category E, vertical earthquake effects (see Clause 6.8) shall be considered for critical components, such as horizontal cantilevers and horizontal prestressed members.

Detailing requirements for structures of earthquake Design Category E shall be in accordance with Clause 4.4.

All masonry components shall be reinforced.

**2.8 STRUCTURAL SYSTEMS OF BUILDINGS** For the purposes of earthquake design, the structural systems of buildings shall be classified as follows:

- (a) *Bearing wall system* A structural system with loadbearing walls providing support for all or most of the vertical loads and shear walls or braced frames providing the horizontal earthquake resistance.  
 (b) *Building frame system* A structural system in which an essentially complete space frame supports the vertical loads and shear walls or braced frames provide the horizontal earthquake resistance.  
 (c) *Moment resisting frame system* A structural system in which an essentially complete space frame supports the vertical loads and the total prescribed horizontal earthquake forces by the flexural action of members.  
 (d) *Dual system* A structural system in which an essentially complete space frame provides support for the vertical loads and at least a quarter of the prescribed horizontal earthquake forces. The total horizontal earthquake resistance is provided by the combination of the moment frame, shear walls or braced frames, in proportion to their relative rigidities.

Once selected, the structural system shall be designed and detailed to ensure that the system will behave in the way intended.

A height limitation of 50 m above the structural base of the structure applies for ordinary moment resisting frames (OMRFs) where the product of acceleration coefficient and site factor ( $aS$ ) is greater than or equal to 0.1.

NOTE: A broad outline of the requirements for structures of concrete, steel, and other materials is given in Paragraph B2 of Appendix B.

## 2.9 CONFIGURATION

**2.9.1 General** For the purposes of earthquake design, structures shall be classified as regular or irregular. Both plan and vertical configurations of a structure shall be considered when determining whether a structure is to be classified as regular or irregular.

**2.9.2 Plan configuration** A structure shall be classified as irregular when any of the following apply:

- (a) *Torsional irregularity* Torsional irregularity shall be considered to exist when the distance between the static centre of mass and the shear centre (centre of rigidity) is in excess of 10% of the structure dimension perpendicular to the direction of the earthquake force.
- (b) *Re-entrant corners* Plan configurations of a structure and its horizontal force-resisting system which contain re-entrant corners, where both projections of the structure beyond a re-entrant corner are greater than 15% of the plan dimension of the structure in the given direction.
- (c) *Diaphragm discontinuity* Diaphragms with abrupt discontinuities or variations in stiffness, including those having cut-out or open areas greater than 50% of the gross enclosed area of the diaphragm.
- (d) *Out-of-plane offsets* Discontinuity in a horizontal force path, such as offsets of the vertical elements.
- (e) *Non-parallel systems* Structures in which the vertical planes of horizontal load-resisting elements are neither parallel to, nor symmetric about the major orthogonal axes of the horizontal force-resisting system.

NOTE: Examples of plan irregularities are given in Paragraph A2.2 and Figure A1 of Appendix A.

**2.9.3 Vertical configuration** A structure shall be classified as irregular when any of the following occurs:

- (a) *Stiffness irregularity (soft storey)* A 'soft storey' is one in which the horizontal stiffness of the storey is less than 70% of that in the storey above or less than 80% of the average stiffness of the three storeys above.
- (b) *Strength irregularity (weak storey)* A 'weak storey' is one in which the storey strength is less than 80% of that in the storey above. The storey strength is the total horizontal load capacity of all earthquake resisting elements sharing the storey shear for the direction under consideration.
- (c) *Gravity load irregularity* Gravity load irregularity shall be considered where the gravity load of any storey is more than 150% of the gravity load of an adjacent storey. A roof which is lighter than the floor below need not be considered.
- (d) *Vertical geometric irregularity* Vertical geometric irregularity shall be considered where the horizontal dimension of the horizontal force-resisting system in any storey is more than 130% of that in an adjacent storey. A single storey attachment, such as a plant room or the like, to a multistorey building need not be considered.
- (e) *In-plane discontinuity in vertical plane of horizontal force-resisting element* In-plane discontinuity shall be considered when the in-plane offset of the horizontal force-resisting element is greater than the length of that element.

NOTE: Examples of vertical irregularities are given in Paragraph A2.3 and Figure A2 of Appendix A.

## 2.10 DEFLECTION AND DRIFT LIMITS

**2.10.1 Portion of structures** All portions of the structure shall be designed and constructed to act as an integral unit in resisting horizontal earthquake forces.

**2.10.2 Adjacent structures** All structures shall be separated from adjacent structures by a distance sufficient to avoid damaging contact. Separations shall allow for  $3(R_f)/8$  times the deflection ( $\delta_x$ ) due to earthquake forces (see Clause 6.7.2), where  $R_f$  is the structural response factor.

The design storey drift ( $\Delta$ ) calculated in accordance with Clause 6.7 shall not exceed  $0.015h_{sx}$  for any storey, where  $h_{sx}$  is the height of storey  $x$ .

NOTE: The deflection ( $\delta_x$ ) is calculated using the ultimate earthquake forces.

## SECTION 3 DOMESTIC STRUCTURES

**3.1 GENERAL** Earthquake design for domestic structures shall comply with the requirements of this Section. Where required, horizontal earthquake resistance shall be provided in two orthogonal directions. Non-structural components of earthquake Design Categories H1, H2 and H3 shall be designed in accordance with Clause 3.5.

NOTE: For guidance on ways of improving horizontal earthquake resistance of domestic structures, see Appendix C.

### 3.2 REQUIREMENTS FOR EARTHQUAKE DESIGN CATEGORIES

**3.2.1 Earthquake Design Category H1** Ductile and non-ductile domestic structures of earthquake Design Category H1 require no specific earthquake design or structural detailing.

**3.2.2 Earthquake Design Category H2** Ductile domestic structures of earthquake Design Category H2 require no specific earthquake design or structural detailing. Non-ductile domestic structures of earthquake Design Category H2 shall be detailed in accordance with Clause 3.3.

**3.2.3 Earthquake Design Category H3** Ductile domestic structures of earthquake Design Category H3 shall be detailed in accordance with Clause 3.3. Non-ductile domestic structures of earthquake Design Category H3 shall be analyzed by static analysis in accordance with Clause 3.4, and shall be detailed in accordance with Clause 3.3.

### 3.3 STRUCTURAL DETAILING REQUIREMENTS FOR DOMESTIC STRUCTURES

**3.3.1 General** The principal requirement for structural detailing is that all parts of the structure shall be tied together both in the horizontal and vertical planes so that forces from all parts of the structure, including structural and non-structural components, generated by earthquake are carried to the foundation.

A connection for resisting a horizontal force shall be provided for each beam or truss to its support which shall have a minimum strength acting along the span of the member equal to 5% of the gravity load reaction for earthquake Design Category H2 and 7.5% for earthquake Design Category H3. Secondary framing members, such as purlins, battens and the like are not required to be designed for earthquake loads but shall be tied to their supporting member and designed as required for other loads.

**3.3.2 Wall anchorage** External walls shall be anchored to the roof and all floors which provide horizontal support for the wall. The anchorage shall provide a connection capable of resisting a force of  $10(aS)$  kN per metre run of wall. Internal loadbearing walls shall be tied to other walls and horizontally restrained at the ceiling and floor planes.

### 3.4 STATIC ANALYSIS FOR NON-DUCTILE DOMESTIC STRUCTURES OF EARTHQUAKE DESIGN CATEGORY H3

**3.4.1 Horizontal forces** The structure shall be designed to resist earthquake forces applied in any horizontal direction.

Walls that are not part of the earthquake resisting system for the direction being considered, shall be designed in accordance with the provisions specified in Clause 3.5.

**3.4.2 Earthquake base shear** The total horizontal earthquake base shear force ( $V$ ) in a given direction shall be determined from the following equation:

$$V = 0.15G_g \quad \dots 3.4.2$$

where

$G_g$  = gravity load (see Clause 6.2.5)



**3.4.3 Vertical distribution of horizontal earthquake forces** The horizontal earthquake force ( $F_x$ ) applied at level  $x$  (see Figure 6.3), shall be determined from the following equation:

$$F_x = \left( \frac{G_{gx}}{G_g} \right) V \quad \dots 3.4.3$$

where

$G_{gx}$  = portion of gravity load ( $G_g$ ) located or applied at level  $x$

$G_g$  = gravity load (see Clause 6.2.5)

$V$  = total horizontal earthquake base shear force calculated from Equation 3.4.2

**3.4.4 Torsional effects** Where the domestic structure is irregular, the design earthquake shear force for each resisting element shall be increased by 25% to allow for torsion. A regular domestic structure for the purposes of this Clause, is defined as a rectangular structure in plan where the ratio of the maximum dimension divided by the minimum dimension of the plan shall not exceed 1.2.

**3.5 NON-STRUCTURAL COMPONENTS** For domestic structures of earthquake Design Categories H1, H2 and H3, non-ductile components, such as unreinforced masonry, gable ends, chimneys and parapets shall be restrained to resist a minimum force of  $1.8(aS)G_c$ , where  $G_c$  is the weight of the component.

Masonry veneer walls which consist of an outer leaf of masonry tied to an inner ductile framing such as timber, steel, etc. and which comply with AS 3700, require no specific design for earthquake.

Unreinforced masonry walls of earthquake Design Category H1 with heights from floor to ceiling or from floor to roof not exceeding 3.2 m and which are horizontally restrained at the ceiling or roof level and are restrained at least at one vertical edge, and which comply with AS 3700, also require no specific design for earthquake.

Design of non-structural components to Section 5 is not required.

## SECTION 4 STRUCTURAL DETAILING REQUIREMENTS FOR GENERAL STRUCTURES

**4.1 GENERAL** General detailing of components of the structural force-resisting system and of other structural components, including minimum forces to be resisted, shall be in accordance with this Section. The principal requirement for structural detailing is that all parts of the structure shall be tied together both in the horizontal and the vertical planes so that forces generated by earthquake from all parts of the structure, including structural and non-structural components, are carried to the foundation.

### 4.2 STRUCTURAL DETAILING REQUIREMENTS FOR STRUCTURES OF EARTHQUAKE DESIGN CATEGORY A

**4.2.1 Ductile structures** There are no specific structural detailing requirements for ductile structures of earthquake Design Category A.

**4.2.2 Non-ductile structures** Non-ductile structures of earthquake Design Category A shall comply with the detailing requirements for structures of earthquake Design Category B (see Clause 4.3).

NOTE: For ductile and non-ductile structures, see Paragraph B1 of Appendix B.

### 4.3 STRUCTURAL DETAILING REQUIREMENTS FOR STRUCTURES OF EARTHQUAKE DESIGN CATEGORY B

**4.3.1 General** In addition to the requirements set out in the appropriate material Standards, structures of earthquake Design Category B shall comply with the detailing requirements set out in Clauses 4.3.2 and 4.3.3.

**4.3.2 Load paths, ties and continuity** The design of the structure shall provide load paths for forces from all parts of the structure, including structural and non-structural components, generated by earthquakes, to be carried to the foundation.

A connection for resisting a horizontal force shall be provided for each beam or truss to its support which shall have a minimum strength acting along the span of the member equal to 5% of the reaction due to gravity load ( $G_g$ ).

**4.3.3 Wall anchorage** Walls shall be anchored to the roof and restrained at all floors which provide horizontal support for the wall. The anchorage or restraint shall provide a connection between the walls and the roof or floor construction and shall be capable of resisting a horizontal earthquake force induced by the wall of  $10(aS)$  kN per metre run of wall. Walls shall be designed to resist bending between anchors where the anchor spacing exceeds 1.2 m.

For non-ductile structures of earthquake Design Category A, a 50% reduction of the force to be resisted is permitted but the force shall not be less than 0.8 kN per metre run of wall.

### 4.4 STRUCTURAL DETAILING REQUIREMENTS FOR STRUCTURES OF EARTHQUAKE DESIGN CATEGORIES C, D AND E

**4.4.1 General** In addition to the requirements of Clause 4.3, structures of earthquake Design Categories C, D and E shall also comply with the detailing requirements set out in Clauses 4.4.2 to 4.4.6.

**4.4.2 Ties and continuity** All parts of the structure shall be interconnected and the connections shall be capable of transmitting the horizontal earthquake force ( $F_p$ ), specified in Section 5, induced by the parts being connected. Any smaller portion of the structure shall be tied to the remainder of the structure with elements having a strength to resist  $0.33(aS)$  times the gravity load of the smaller part but not less than 5% of the portion's weight.

**4.4.3 Diaphragms** The deflection in the plane of the diaphragm, as determined by analysis, shall not exceed the permissible deflection of the attached elements. Permissible deflection shall be that deflection which will permit the attached element to maintain its structural integrity under the individual loading and continue to support the prescribed loads without endangering the occupants of the structure.

Floor and roof diaphragms shall be designed as follows:

- (a) To resist horizontal earthquake forces of a minimum force equal to  $0.5(aS)$  times the weight of the diaphragm and other elements of the structure attached thereto plus the portion of the horizontal earthquake shear force at storey  $x$  ( $V_x$ ) required to be transferred to the components of the vertical earthquake-resisting system because of offsets or changes in stiffness of the vertical components above and below the diaphragm.
- (b) To have ties or struts to distribute the wall anchorage forces, as specified in Clauses 4.3.3 and 5.2.1.

**4.4.4 Bearing walls** Interconnection of dependent wall elements and connections to supporting framing systems shall have ductility or rotational capacity, or strength to resist shrinkage, thermal changes, and differential foundation settlement when combined with earthquake forces.

**4.4.5 Openings** Where openings occur in shear walls, diaphragms or other plate-like elements, strengthening shall be provided at the edges of the openings to resist the local stresses created by the presence of the opening.

**4.4.6 Footing ties** Footings supported on piles, or caissons, or spread footings which are located in or on soils with a maximum ultimate bearing value of less than 250 kPa shall be restrained in any horizontal direction by ties or other means to limit differential horizontal movement during an earthquake. The ties or other means shall be capable of carrying, in tension or compression, a force equal to  $0.25(aS)$  times the larger footing or column load.

## SECTION 5 REQUIREMENTS FOR NON-STRUCTURAL COMPONENTS

### 5.1 GENERAL REQUIREMENTS

**5.1.1 General** This Section need not be applied to components of domestic structures. For the purposes of this Section, non-structural components shall be categorized as either architectural, or mechanical and electrical components.

All non-structural components and portions thereof shall be designed and constructed to resist earthquake forces except for the following:

- (a) Ductile architectural, mechanical and electrical components of structures of earthquake Design Category A.
- (b) Ducts and piping distribution systems where earthquake restraint is not required (see Clause 5.3.2).

**5.1.2 Forces on components** The horizontal earthquake force on any component shall be applied at the centre of gravity of the component and shall be assumed to act in any horizontal direction. Vertical earthquake forces on mechanical and electrical components shall be taken as 50% of the horizontal earthquake force.

**5.1.3 Interrelationship of components** The effects on the response of the structural system and the deformation compatibility of the architectural, electrical, and mechanical components shall be considered where there is interaction of these components with the structural system.

The interrelationship of components and their effects on each other shall be considered so that the failure of an architectural, mechanical, or electrical component shall not cause a component critical to the safety of the structure to fail.

**5.1.4 Connections and attachments** Architectural, electrical, and mechanical components required to be designed to resist earthquake forces shall be attached so that the forces are transferred to the structure. The attachment shall be designed to resist the earthquake forces specified in this Section.

Friction due to gravity shall not be considered in evaluating the required resistance to earthquake forces.

Minimum anchorage forces for walls are specified in Section 4.

Flexible mounting devices shall be fitted with restraining devices to limit the horizontal and vertical motions, to inhibit the development of resonance in the flexible mounting system, and to prevent overturning.

**5.1.5 Earthquake coefficients** Earthquake coefficients for the appropriate architectural components ( $C_{c1}$ ), and mechanical and electrical components ( $C_{c2}$ ), shall be as given in Tables 5.1.5(a) and 5.1.5(b) respectively.

**TABLE 5.1.5(a)**  
**EARTHQUAKE COEFFICIENT**  
**FOR ARCHITECTURAL COMPONENTS**

Architectural component	Earthquake coefficient ( $C_{cl}$ )
Appendages	
1 Parapets (see Note 1), gables, verandahs, awnings, canopies and chimneys	1.8
2 Roofing components (tiles, metal panels)	0.6
3 Containers and miscellaneous components	1.5
Fasteners	
4 Connectors for wall attachments, curtain walls, exterior non-loadbearing walls	$2C_{cl}$ for relevant component
Walls and partitions	
5 Exterior ductile walls with ductile fixings	0.9
6 Exterior non-ductile walls	1.8
7 Adjacent to or enclosing stairs, stair shafts, lifts and required exit paths	1.5
8 Enclosing vertical shafts (ducts and risers)	0.9
9 Full height partitions required to have an FRL	0.9
10 Other partitions	0.6
Ceilings	
11 With required FRL	0.9
12 With non-required FRL	0.6
Floors	
13 Access floor systems (see Note 2)	2.0
Architectural equipment	
14 Storage racks and library shelves with a height over 2.0 m	0.9

LEGEND:

FRL = fire-resistance level

NOTES TO TABLE 5.1.5(a):

- 1 Unrestrained (cantilever) masonry parapets are not recommended.
- 2 The weight of the floor system should be determined in accordance with Clause 6.2.5.

**TABLE 5.1.5(b)**  
**EARTHQUAKE COEFFICIENT FOR MECHANICAL AND**  
**ELECTRICAL COMPONENTS**

Mechanical/electrical component	Earthquake coefficient ( $C_c$ )
Smoke control systems	2.0
Emergency electrical systems (including battery racks)	2.0
Fire and smoke detection systems	2.0
Fire suppression systems (including sprinklers)	2.0
Life safety system components	2.0
Anchorage of lift machinery and anchorage of controller	1.25
Lift and hoist components, structural frame providing support for guide rail brackets, guide rails and brackets, car and counter weight members	1.25
Escalators	1.25
Boilers, furnaces, incinerators, water heaters, and other equipment using combustible energy sources or high-temperature energy sources, chimneys, flues, smokestacks, vents and pressure vessels	2.0
Communication systems:	
cable systems	2.0
motor control devices, switchgear	2.0
transformers, and unit substations	2.0
Reciprocating or rotating equipment	2.0
Utility and service interfaces	2.0
Machinery (manufacturing and process)	0.7
Lighting fixtures	0.7
Ducts and piping distribution systems	1.0 (see Clause 5.3.2)
Electrical panelboards and dimmers	0.7
Conveyor systems (non-personnel)	0.7

## 5.2 REQUIREMENTS FOR ARCHITECTURAL COMPONENTS

**5.2.1 Forces** Architectural components and their attachments shall be designed to resist horizontal earthquake forces in accordance with established principles of structural dynamics or determined from the following equation:

$$F_p = aSa_c a_x C_{c1} I G_c \leq 0.5G_c \quad \dots 5.2.1$$

where

$F_p$  = horizontal earthquake force applied to a component of a structure or equipment at its centre of gravity

$a$  = acceleration coefficient (see Table 2.3 or Figures 2.3(b) to 2.3(g))

$S$  = site factor (see Table 2.4(a))

$a_c$  = attachment amplification factor (see Clause 5.4.1). It may be assumed to be equal to unity unless unusually flexible connections are provided, in which case guidance may be obtained from Clause C5.4.1

$a_x$  = height amplification factor at level  $x$  (see Clause 5.4.2)

$C_{c1}$  = earthquake coefficient for architectural components (see Table 5.1.5(a)). Where architectural components are not specifically listed in Table 5.1.5(a),  $C_{c1}$  shall be selected for a similar component that is listed.

$I$  = importance factor (see Table 2.5)

$G_c$  = weight of a component

The horizontal earthquake force ( $F_p$ ) shall be applied in combination with the gravity load of the element.

**5.2.2 Exterior wall panel attachment** Attachment of exterior wall panels to the structure earthquake resisting system shall have sufficient ductility and rotational capacity to accommodate the design storey drift ( $\Delta$ ) determined in accordance with Clause 6.7.

**5.2.3 Component deformation** Provisions shall be made in the architectural component for the design storey drift ( $\Delta$ ) as determined in accordance with Clause 6.7. Provision shall be made for vertical deflection due to joint rotation of cantilever members.

**5.2.4 Out-of-plane bending** Transverse or out-of-plane bending, or deformation of a component that is subjected to forces determined from Equation 5.2.1 shall not exceed the deflection capability of the component.

### 5.3 REQUIREMENTS FOR MECHANICAL AND ELECTRICAL COMPONENTS

**5.3.1 Forces** Mechanical and electrical components and their attachments shall be designed to resist horizontal earthquake forces in accordance with established principles of structural dynamics or determined from the following equation:

$$F_p = a S a_c a_x C_{c2} I G_c \leq 0.5 G_c \quad \dots 5.3.1$$

where  $C_{c2}$  is the earthquake coefficient for mechanical or electrical components (see Table 5.1.5(b)). Where mechanical or electrical components are not specifically listed in Table 5.1.5(b),  $C_{c2}$  shall be selected for a similar component that is listed.

The horizontal earthquake force ( $F_p$ ) shall be applied in combination with the gravity load of the element.

**5.3.2 Ducts and piping distribution systems** Earthquake restraints for ducts and piping distribution systems of earthquake Design Categories A and B are not required.

Earthquake restraints for ducts and piping distribution systems of earthquake Design Categories C, D and E shall be provided except in the following circumstances:

- (a) Gas piping less than 25 mm inside diameter.
- (b) Piping in boiler and mechanical rooms less than 32 mm inside diameter.
- (c) All other piping less than 64 mm inside diameter.
- (d) All electrical conduit less than 64 mm inside diameter.
- (e) All rectangular air-handling ducts less than 0.4 m<sup>2</sup> in cross-sectional area.
- (f) All round air-handling ducts less than 700 mm in diameter.
- (g) All ducts and piping suspended by individual hangers 300 mm or less in length from the top of the pipe to the bottom of the support for the hanger.

## 5.4 AMPLIFICATION FACTOR

**5.4.1 Attachment amplification factor** The attachment amplification factor ( $a_c$ ) shall be determined as follows:

- (a) For fixed or direct attachment to the structure:  $a_c = 1$
- (b) For flexible mounting system:
  - (i) with horizontal deflection control device:  $a_c = 1$
  - (ii) without horizontal deflection control device:
    - (A)  $T_c/T < 0.6$  or  $T_c/T > 1.4$ :  $a_c = 1$
    - (B)  $0.6 \leq T_c/T \leq 1.4$ :  $a_c = 2$
    - (C) If mounted on the ground or on a slab in direct contact with the ground:  $a_c = 2$

The value of the structure period ( $T$ ), in seconds, shall be the value used in the design of the structure as determined in accordance with Clause 6.2.4.

The period of vibration ( $T_c$ ), in seconds, of the component and its attachment may be determined from the following equation:

$$T_c = 2\pi \sqrt{\frac{G_c}{gK}} \quad \dots 5.4.1$$

where

- $G_c$  = weight of a component
- $g$  = gravitational constant (9.81 m/sec<sup>2</sup>)
- $K$  = stiffness of the attachment in the relevant direction

Alternatively, properly substantiated values for  $T_c$  derived using experimental data or any accepted analytical procedure may be used instead of Equation 5.4.1.

**5.4.2 Height amplification factor** The height amplification factor ( $a_x$ ) at level  $x$  shall be determined from the following equation:

$$a_x = 1 + \left( \frac{h_x}{h_n} \right) \quad \dots 5.4.2$$

where

- $h_x$  = height above the structural base of the structure at which the component is attached
- $h_n$  = total height of the structure above the structural base



## SECTION 6 STATIC ANALYSIS

**6.1 GENERAL** Static analysis, when used, shall conform to the criteria established in this Section.

### 6.2 HORIZONTAL FORCES

**6.2.1 General** Structures shall be designed to resist earthquake forces applied in any horizontal direction.

The horizontal design earthquake forces may be assumed to act non-concurrently in the direction of each principal axis of the structure except for the following:

- (a) The structure components and footings that participate in resisting horizontal earthquake forces in both main axes of the structure.
- (b) The structure is classified as irregular (see Item (a) or Item (e) of Clause 2.9.2).

For these two cases, the structure components and footings shall be designed for the additive effect of 100% of the horizontal earthquake forces for one direction and 30% in the perpendicular direction. The combination requiring the greater component strength shall be used for design.

NOTE: Walls that are not part of the earthquake resisting system for the direction being considered should be designed in accordance with the provisions specified in Section 5.

**6.2.2 Earthquake base shear** The total horizontal earthquake base shear force ( $V$ ) in a given direction shall be determined from the following equation:

$$V = I \left( \frac{CS}{R_f} \right) G_g \quad \dots 6.2.2$$

within the limits:

$$V \geq 0.01G_g$$

and

$$V \leq I \left( \frac{2.5a}{R_f} \right) G_g$$

where

$I$  = importance factor (see Table 2.5)

$C$  = earthquake design coefficient (see Clause 6.2.3)

$S$  = site factor (see Clause 2.4)

$R_f$  = structural response factor (see Clause 6.2.6)

$G_g$  = gravity load (see Clause 6.2.5)

$a$  = acceleration coefficient (see Table 2.3 or Figures 2.3(b) to 2.3(g)).

**6.2.3 Earthquake design coefficient** The earthquake design coefficient ( $C$ ) shall be determined from the following equation:

$$C = \frac{1.25a}{T^{2/3}} \quad \dots 6.2.3$$

where  $T$  is the structure period, in seconds (see Clause 6.2.4).

**6.2.4 Structure period** The structure period ( $T$ ), in seconds, may be determined by a rigorous structural analysis. Alternatively, the fundamental period of a structure and,

where the structure has different properties in two orthogonal directions, the period for the orthogonal direction for structures of uniform vertical distribution of mass and stiffness may be approximated from the following equations:

$$\text{Fundamental period: } T = \frac{h_n}{46} \quad \dots 6.2.4(1)$$

$$\text{Period for the orthogonal direction: } T = \frac{h_n}{58} \quad \dots 6.2.4(2)$$

where

$h_n$  = total height of the structure above the structural base in metres

The fundamental period shall be associated with the more flexible structure direction and the period for the orthogonal direction shall be associated with the most rigid structure direction.

The earthquake design coefficient ( $C$ ) obtained from Equation 6.2.3 using the structure period ( $T$ ) determined by a rigorous structural analysis shall be not less than 80% of the value obtained using  $T$  from Equations 6.2.4(1) and 6.2.4(2).

**6.2.5 Gravity load** The gravity load ( $G_g$ ) shall be determined from the following equation:

$$G_g = G + \psi_c Q \quad \dots 6.2.5$$

where

$G$  = dead load (see AS 1170.1)

$\psi_c$  = live load combination factor used in assessing the design load for strength and stability limit states (see AS 1170.1)

$Q$  = live load (see AS 1170.1)

**6.2.6 Structural response factor** The structural response factor ( $R_f$ ) for the appropriate building and non-building structures, shall be as given in Tables 6.2.6(a) and 6.2.6(b) respectively.

### 6.3 VERTICAL DISTRIBUTION OF HORIZONTAL EARTHQUAKE FORCES

The horizontal earthquake force ( $F_x$ ) applied at level  $x$  (see Figure 6.3), shall be determined from the following equation:

$$F_x = C_{vx} V \quad \dots 6.3(1)$$

where

$C_{vx}$  = earthquake design coefficient for vertical distribution of horizontal earthquake forces

$$= \frac{G_{gx} h_x^k}{\sum_{i=1}^n G_{gi} h_i^k} \quad \dots 6.3(2)$$

$G_{gx}$  = portion of gravity load ( $G_g$ ) located or applied at level  $x$

$G_{gi}$  = portion of gravity load ( $G_g$ ) located or applied at level  $i$

- $h_x$  = height above the structural base of the structure to level  $x$   
 $h_i$  = height above the structural base of the structure to level  $i$   
 $n$  = number of levels in structure  
 $k$  = an exponent dependent on the structure period ( $T$ ), taken as—  
 (a) 1.0 when  $T \leq 0.5$ ; or  
 (b) 2.0 when  $T \geq 2.5$ .  
 $k$  may be linearly interpolated between 1.0 and 2.0 for  $0.5 < T < 2.5$ .

**TABLE 6.2.6(a)**  
**STRUCTURAL RESPONSE FACTOR ( $R_f$ ) AND DEFLECTION**  
**AMPLIFICATION FACTOR ( $K_d$ ) FOR BUILDING STRUCTURES**

Structural system	Description	$R_f$	$K_d$	
Bearing wall system	Light framed walls with shear panels	6.0	4.0	
	Reinforced concrete shear walls	4.5	4.0	
	Reinforced masonry shear walls	4.0	3.0	
	Concentrically-braced frames	4.0	3.5	
	Unreinforced masonry shear walls	1.5	1.25	
Building frame system	Eccentrically-braced steel frames	7.0	4.0	
	Light-framed walls with shear panels	7.0	4.5	
	Concentrically-braced frames	5.0	4.5	
	Reinforced concrete shear walls	6.0	5.0	
	Reinforced masonry shear walls	5.0	4.0	
	Unreinforced masonry shear walls	1.5	1.5	
Moment resisting frame system	Special moment resisting frames of steel	8.0	5.5	
	Special moment resisting frames of reinforced concrete	8.0	5.5	
	Intermediate moment resisting frames of steel	6.5	4.5	
	Intermediate moment resisting frames of reinforced concrete	6.0	3.5	
	Ordinary moment resisting frames of steel	4.5	4.0	
	Ordinary moment resisting frames of reinforced concrete	4.0	2.0	
Dual system:	(a) with a special moment resisting frame	Eccentrically-braced steel frames	8.0	4.0
		Concentrically-braced frames	6.5	5.0
		Reinforced concrete shear walls	8.0	6.5
		Reinforced masonry shear walls	6.5	5.5
	(b) with an intermediate moment resisting frame of reinforced concrete or an ordinary moment resisting frame of steel	Concentrically-braced frames	5.5	4.5
		Reinforced concrete shear walls	6.0	5.0
		Reinforced masonry shear walls	5.5	4.5

**TABLE 6.2.6(b)**  
**STRUCTURAL RESPONSE FACTOR ( $R_f$ )**  
**FOR NON-BUILDING STRUCTURES**

Type of structure	$R_f$
Tanks, vessels or pressurized spheres on braced or unbraced legs	2.1
Cast-in-place concrete silos and chimneys having walls continuous to the foundation	3.6
Distributed mass cantilever structures, such as stacks, chimneys, silos and skirt-supported vertical vessels	2.8
Trussed towers (freestanding or guyed), guyed stacks and chimneys	2.8
Inverted pendulum-type structures	2.1
Cooling towers	3.6
Bins and hoppers on braced or unbraced legs	2.8
Storage racking	3.6
Signs and billboards	3.6
Amusement structures and monuments	2.1
All other self-supporting structures not otherwise covered	2.8

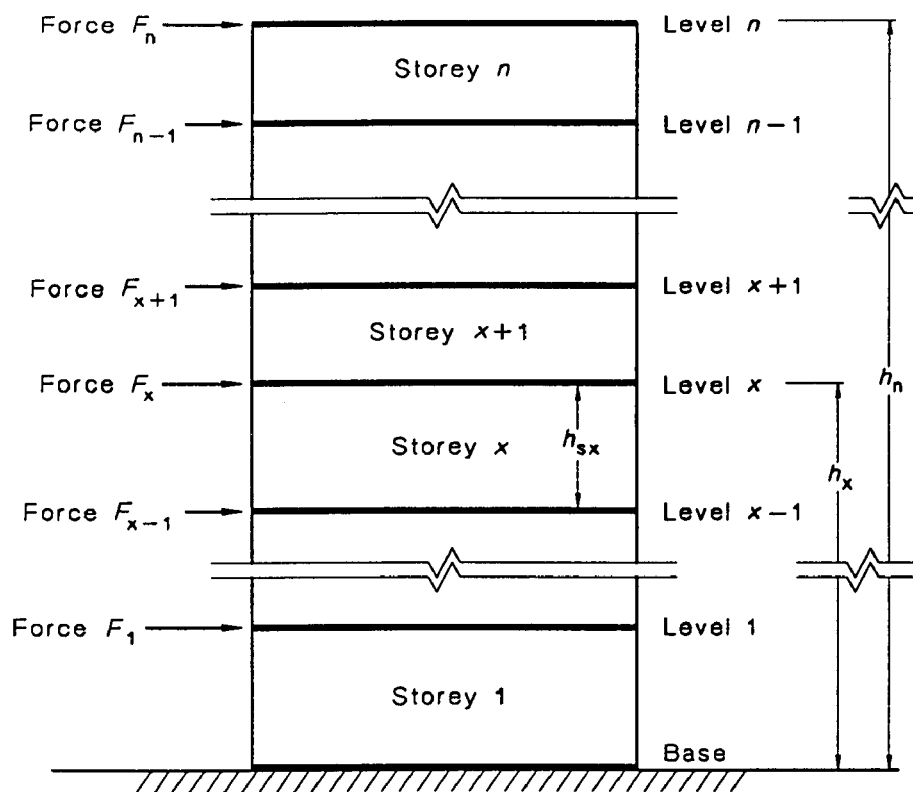

NOTE: The horizontal earthquake shear force ( $V_x$ ) at storey  $x$  is the sum of all the horizontal forces at and above level  $x$  ( $F_x$  to  $F_n$ ).

FIGURE 6.3 ILLUSTRATION OF FORCE, STOREY AND LEVEL

**6.4 HORIZONTAL SHEAR DISTRIBUTION** The horizontal earthquake shear force ( $V_x$ ) at storey  $x$  (storey shear) shall be determined from the following equation:

$$V_x = \sum_{i=x}^n F_i \quad \dots 6.4$$

where

$F_i$  = horizontal earthquake force at level  $i$

$n$  = number of levels in structure

The horizontal earthquake shear force ( $V_x$ ) shall be distributed to the various vertical components of the earthquake resisting system (resisting elements) in the storey below level  $x$  with due consideration given to the relative stiffnesses of the vertical components and the diaphragm.

## 6.5 TORSIONAL EFFECTS

**6.5.1 Introduction** Provision shall be made for the changes in design action effects (shear forces) acting on resisting elements at storey  $x$ , resulting from horizontal torsion. For each resisting element, consideration shall be given to the more unfavourable change in design action effect resulting from either of the horizontal torsional moments specified in Clause 6.5.4.

**6.5.2 Static eccentricity** The static eccentricity ( $e_s$ ) at storey  $x$  (see Figure 6.5.3.1) shall be taken as the distance between—

- (a) the line of action of the horizontal earthquake force ( $F_x$ ) acting through the centre of mass of level  $x$ ; and
- (b) the shear centre of storey  $x$ .

**6.5.3 Design eccentricities** The design eccentricities of storey  $x$  ( $e_{d1}$  and  $e_{d2}$ ) (see Figure 6.5.3.1) shall be determined from the following equations:

$$e_{d1} = A_1 e_s + 0.05b \quad \dots 6.5.3(1)$$

$$e_{d2} = A_2 e_s - 0.05b \quad \dots 6.5.3(2)$$

where

$e_{d1}$  = primary design eccentricity

$e_{d2}$  = secondary design eccentricity

$A_1$  = dynamic eccentricity factor (see Figure 6.5.3.2)

=  $[2.6 - 3.6(e_s/b)]$  or 1.4, whichever is the greater

$A_2$  = dynamic eccentricity factor (see Figure 6.5.3.2)

= 0.5

$e_s$  = static eccentricity as defined in Clause 6.5.2 (see Figure 6.5.3.1)

$b$  = maximum dimension of the structure at level  $x$ , measured perpendicular to the horizontal earthquake shear force direction at the level under consideration (see Figure 6.5.3.1)

The second term in both equations is the accidental eccentricity.

The effects of torsion shall be calculated in accordance with Clauses 6.5.4 and 6.5.5. For Type I regular structures with shear resisting elements at the structure perimeter and without static eccentricity, the design earthquake shear force on each resisting element may alternatively be increased by 30% to allow for torsion.

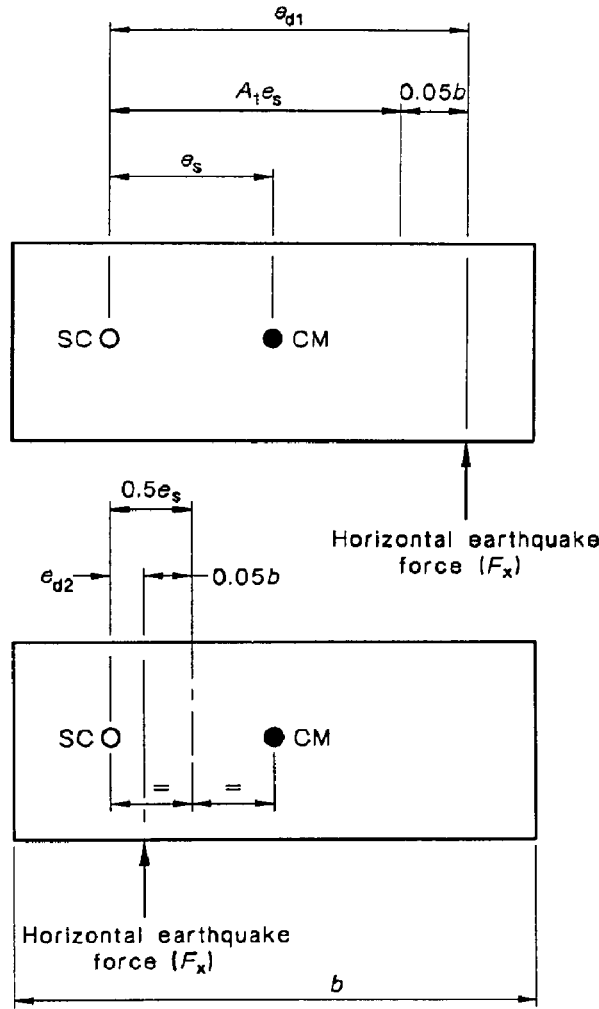

LEGEND:  
 SC = shear centre of level  $x$   
 CM = centre of mass of level  $x$   
 $e_{d1}$  = primary design eccentricity  
 $e_{d2}$  = secondary design eccentricity

FIGURE 6.5.3.1 GEOMETRIC ECCENTRICITIES

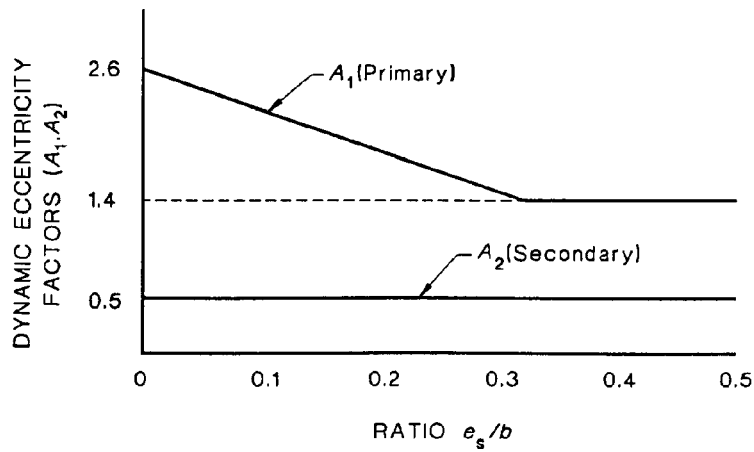

FIGURE 6.5.3.2 DYNAMIC ECCENTRICITY FACTORS

**6.5.4 Horizontal torsional moments** The corresponding horizontal torsional moments at storey  $x$  are given by the products of—

- (a) the horizontal earthquake shear force ( $V_x$ ) at storey  $x$  (see (Clause 6.4)); and
- (b) the distance from the shear centre of storey  $x$  to the line of action of the horizontal earthquake shear force ( $V_x$ ). The line of action of  $F_i$  at each level shall be assumed to act at the design eccentricity ( $e_{d1}$ ) or ( $e_{d2}$ ) of that level.

**6.5.5 Design action effects resulting from torsional moments** Using the method of distributing the horizontal earthquake shear force ( $V_x$ ) determined in accordance with Clause 6.4, design action effects shall be calculated for each of the torsional moments specified in Clause 6.5.4 separately.

For each resisting element, these design action effects shall be added to the design action effects resulting from the horizontal earthquake shear forces specified in Clause 6.4, to establish the more unfavourable combination for the resisting element under consideration.

**6.6 STABILITY EFFECTS** Structures shall be designed for an overturning moment ( $M$ ) of the whole structure calculated from the following equation:

$$M = \alpha \sum_{i=1}^n F_i h_i \quad \dots 6.6$$

where

$\alpha$  = 0.75 for all structures except inverted pendulum structures

= 1.00 for inverted pendulum structures

$n$  = number of levels in structure

$F_i$  = horizontal earthquake force at level  $i$

$h_i$  = height above the base of the structure to level  $i$

Inverted pendulum structures shall be designed for the bending moment calculated at the base and varying uniformly to a moment at the top equal to 50% of the calculated bending moment at the base.

## 6.7 DRIFT DETERMINATION AND *P*-DELTA EFFECTS

**6.7.1 General** Storey drifts, member forces and moment due to *P*-delta effects shall be determined in accordance with this Section.

**6.7.2 Storey drift determination** Storey drifts shall be assessed for the two major axes of a structure considering horizontal earthquake forces acting independently but not simultaneously in each direction. The design storey drift ( $\Delta$ ) shall be calculated as the difference of the deflections ( $\delta_x$ ) at the top and bottom of the storey under consideration. The deflections ( $\delta_x$ ) shall be determined from the following equation:

$$\delta_x = K_d \delta_{xe} \quad \dots 6.7.2$$

where

$K_d$  = deflection amplification factor (see Table 6.2.6(a))

$\delta_{xe}$  = deflection determined by an elastic analysis using ultimate earthquake forces

For regular structures, the elastic analysis for storey drift determination shall be carried out using the horizontal earthquake forces ( $F_x$ ) specified in Clause 6.3, applied to the structure through the centre of mass for each floor, e.g. the additional torsional effects specified in Clause 6.5 may be neglected.

For irregular structures, the elastic analysis for storey drift determination shall be carried out using the horizontal earthquake forces ( $F_x$ ) specified in Clause 6.3, applied to the structure in accordance with Clause 6.5.

Where applicable, the design storey drift ( $\Delta$ ) shall be increased to allow for the  $P$ -delta effects.

**6.7.3  $P$ -delta effects**  $P$ -delta effects on horizontal earthquake shear forces and moments, the resulting member forces and moments, and the storey drifts induced by these effects need not be considered when the stability coefficient ( $m$ ) as determined from the following equation is equal to or less than 0.10:

$$m = \frac{P_x \Delta}{V_x h_{sx} K_d} \quad \dots 6.7.3$$

where

- $P_x$  = total vertical design load at storey  $x$
- $\Delta$  = design storey drift (see Clause 6.7.2)
- $V_x$  = horizontal earthquake shear force at storey  $x$
- $h_{sx}$  = height of storey  $x$  (see Figure 6.3)
- $K_d$  = deflection amplification factor (see Table 6.2.6(a))

When  $m$  is greater than 0.10, the deflection amplification factor ( $K_d$ ) related to  $P$ -delta effects shall be determined by rational analysis.

The design storey drift ( $\Delta$ ) determined in accordance with Clause 6.7.2 shall be multiplied by the factor  $(0.9/(1 - m))$ , which is greater than or equal to 1, to obtain the storey drift including  $P$ -delta effect. Alternatively, a second order analysis may be used to obtain the storey drift including  $P$ -delta effects.

The increase in horizontal earthquake shear forces and moments resulting from the increase in storey drift shall be added to the corresponding shear forces and moments determined without consideration of the  $P$ -delta effect.

**6.8 VERTICAL COMPONENT OF GROUND MOTION** The vertical earthquake ground motion shall be considered for structures of earthquake Design Categories D and E when its effects are significant. The vertical component of ground motion may be defined by scaling corresponding horizontal accelerations by a factor of 0.5.



## SECTION 7 DYNAMIC ANALYSIS

**7.1 GENERAL** Dynamic analysis, when used, shall conform to the criteria established in this Section. The analysis shall be based on an appropriate ground motion representation in accordance with Clause 7.2. The mathematical model used shall be in accordance with Clause 7.3. The method of analysis shall be in accordance with Clause 7.4.

NOTE: Information on types of dynamic analysis is given in Appendix D.

**7.2 EARTHQUAKE ACTIONS** The earthquake ground motion shall be accounted for by one of the following—

- the response spectra as shown in Figure 7.2 which are normalized by the acceleration coefficient ( $a$ ) specified in Clause 2.3. In order to use this, the spectra shall be multiplied by the appropriate acceleration coefficient ( $a$ ) and the ratio  $I/R_f$  in order to account for structural importance and ductility, where  $I$  is the importance factor (see Clause 2.5) and  $R_f$  is the structural response factor (see Clause 6.2.6);
- design response spectra developed for the specific site taking into account the structural importance and ductility. The ground motion represented by the spectra shall be based on the geological, tectonic, earthquake recurrence information and foundation material properties associated with the specific site; or
- ground motion time histories chosen for the specific site. They shall be representative of actual earthquake motions. Response spectra from these time histories, either individually or in combination, shall approximate the site design spectrum conforming to Item (a).

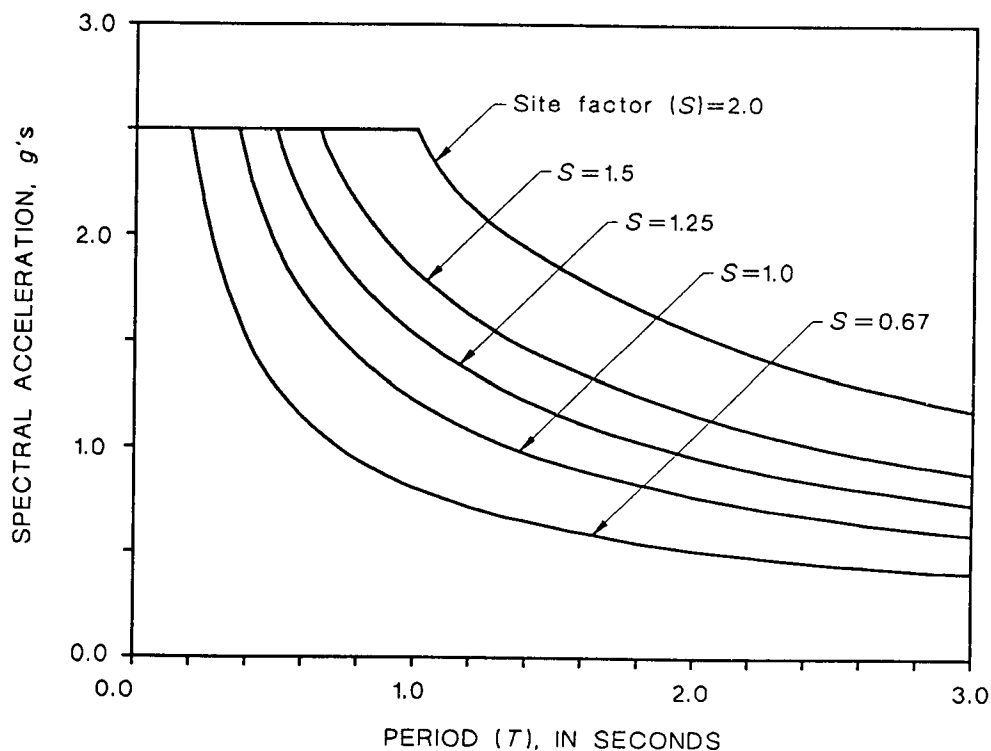

FIGURE 7.2 NORMALIZED RESPONSE SPECTRA

**7.3 MATHEMATICAL MODEL** A mathematical model of the physical structure shall represent the spatial distribution of the mass and stiffness of the structure to an extent which is adequate for the calculation of the significant features of its dynamic response. Where dynamic analysis is required by Clause 2.7, a three-dimensional model shall be used.

#### 7.4 ANALYSIS PROCEDURES

**7.4.1 General** The analysis procedure may be either a response spectrum analysis in accordance with Clause 7.4.2 or a time history analysis in accordance with Clause 7.4.3.

##### 7.4.2 Response spectrum analysis

**7.4.2.1 General** A dynamic analysis of a structure by the response spectrum method shall use the peak response of all modes having a significant contribution to the total structural response as specified in Clause 7.4.2.2. Peak modal responses shall be calculated using the ordinates of the appropriate response spectrum curve specified in Clause 7.2, Item (a) or (b) which correspond to the modal periods. Maximum modal contributions shall be combined in accordance with Clause 7.4.2.3.

**7.4.2.2 Number of modes** A sufficient number of modes shall be included in the calculation of the response so that for each principal horizontal direction at least 90% of the structure's gravity load has been accounted for.

**7.4.2.3 Combining modes** The peak member forces, displacements, horizontal earthquake shear forces and base reactions for each mode shall be combined by a recognized method. When modal periods are closely spaced, modal interaction effects shall be considered.

**7.4.2.4 Scaling of results** The horizontal base shear force for a given direction determined by using these procedures, when less than the values given below, shall be scaled up to these values as follows:

- (a) The horizontal base shear force shall be increased to the following percentage of the values determined from the procedures of Section 6:
  - (i) 100% for irregular buildings.
  - (ii) 90% for regular buildings except that the horizontal base shear force shall not be less than 80% of that determined by using the structure period ( $T$ ) from Equations 6.2.4(1) and 6.2.4(2).

All corresponding response parameters, including deflections, member forces and moments, shall be increased proportionately.

- (b) The horizontal base shear force for a given direction determined using these procedures need not exceed that required by Item (a). All corresponding response parameters shall be adjusted proportionately.

**7.4.2.5 Directional effects** Directional effects for horizontal ground motion shall conform to the requirements of Clause 6.2.1. The effect of vertical ground motion shall be considered in accordance with Clause 6.8.

Alternatively, vertical earthquake response may be determined by dynamic response methods. In no case shall the vertical response used for design be less than that obtained in accordance with Clause 6.8.

**7.4.2.6 Torsion** The analysis shall take account of torsional effects, including accidental torsional effects as described in Clause 6.5. Where three-dimensional models are used for analysis, the effects of accidental torsion shall be accounted for, either by appropriate adjustments in the model, such as adjustment of mass locations, or by equivalent static procedures, such as described in Clause 6.5.

**7.4.3 Time history analysis** A dynamic analysis of a structure by the time history method involves calculating the response of a structure at each increment of time when the base is subjected to a specific ground motion time history. The analysis shall be based on well-established principles of mechanics using ground motion records in accordance with Clause 7.2(c).

**7.5 STABILITY EFFECTS** Structures shall be designed for an overturning moment ( $M$ ) calculated by the dynamic response method taking into account the requirements of Clause 7.4.2.4.

**7.6 DRIFT DETERMINATION AND *P*-DELTA EFFECTS** Storey drifts, member forces and moments due to *P*-delta effects shall be calculated in accordance with Clause 6.7 using the deflections, forces and moments calculated by the dynamic response method taking into account the requirements of Clause 7.4.2.4.

## S E C T I O N 8   S T R U C T U R A L   A L T E R A T I O N S

It is permitted to make structural alterations to existing structures provided that the resistance to horizontal earthquake forces is not less than that before such alterations were made, or that the structure as altered complies with the requirements of this Standard. This Section does not apply to domestic structures.

NOTE: For guidance to structural alterations, see Appendix E.

APPENDIX A  
STRUCTURE CLASSIFICATION  
(Informative)

**A1 STRUCTURE CLASSIFICATION** Regulatory authorities may designate any structure to any classification type when special local conditions make this desirable. The following examples of classification types are given:

- (a) *Examples of structure classification Type III:*
- (i) Fire-fighting facilities.
  - (ii) Police facilities.
  - (iii) Ambulance stations.
  - (iv) Emergency vehicle garages.
  - (v) Medical facilities for surgery and emergency treatment.
  - (vi) Power stations.
  - (vii) Emergency centres.
  - (viii) Structures housing toxic or explosive substances in sufficient quantities to be dangerous to the public if released.
- (b) *Examples of structure classification Type II:*
- (i) Public assembly for 100 or more persons.
  - (ii) Open-air stands for 2000 or more persons.
  - (iii) Day-care centres for 50 or more persons.
  - (iv) Schools.
  - (v) Colleges and universities.
  - (vi) Retail stores with an area of more than 500 m<sup>2</sup> per floor or more than 10 m high from the ground to the roof.
  - (vii) Shopping centres with covered malls, 3000 m<sup>2</sup> or more gross area excluding parking.
  - (viii) Offices over four storeys high or more than 1000 m<sup>2</sup> per floor.
  - (ix) Hotels, motels and the like over four storeys high.
  - (x) Apartment houses over four storeys high.
  - (xi) Hospital facilities other than those of Type III.
  - (xii) Wholesale stores or warehouses over four storeys high.
  - (xiii) Factories over four storeys high.
  - (xiv) Heavy machinery plants over four storeys high.
  - (xv) Corrective institutions.
- (c) *Examples of structure classification Type I:*
- (i) Public assembly for fewer than 100 persons.
  - (ii) Open-air stands for fewer than 2000 persons.
  - (iii) Day-care centres for fewer than 50 persons.

- (iv) Retail stores with an area of less than or equal to 500 m<sup>2</sup> per floor or less than or equal to 10 m high from the ground to the roof.
- (v) Shopping centres with covered malls, up to 3000 m<sup>2</sup> gross area excluding parking.
- (vi) Offices up to four storeys high or up to 1000 m<sup>2</sup> per floor.
- (vii) Hotels, motels and the like up to four storeys high.
- (viii) Apartment houses up to four storeys high.
- (ix) Wholesale stores or warehouses up to four storeys high.
- (x) Factories up to four storeys high.
- (xi) Heavy machinery plants up to four storeys high.

Structures which have multiple uses should be assigned the classification of the highest type which occupies 15% or more of the total structure area.

Access to structures of classification Type III should be protected. Where access is through another structure, that structure should also conform to the requirement of classification Type III. Where access is within 3 m of side property lines, protection against potential falling hazards from adjacent properties should be provided.

## A2 CONFIGURATION

**A2.1 General** The configuration of a structure can significantly affect its performance during a strong earthquake. Configuration can be divided into two aspects, plan configuration and vertical configuration. Past earthquakes have repeatedly shown that structures which have irregular configurations suffer greater damage than structures having regular configurations. This situation prevails even with good design and construction. These provisions are intended to encourage the designer to design structures having regular configurations.

**A2.2 Plan configuration** Examples of plan irregularities are shown in Figure A1 and specified as follows:

- (a) A structure may have symmetrical geometric shape without re-entrant corners or wings but still be classified as irregular in plan because of the distribution of mass or vertical earthquake-resisting elements.
- (b) A structure having a regular configuration can be square, rectangular, or circular. A square or rectangular structure with minor re-entrant corners would still be considered regular but large re-entrant corners creating a crucifix form would be classified as an irregular configuration. The response of the wings of this type of structures is generally different from the response of the structure as a whole, and this produces higher local forces than would be determined by application of the Standard without modification. Other plan configurations such as H-shapes that have a geometrical symmetry also would be classified as irregular because of the response of the wings.
- (c) Significant differences in stiffness between portions of a diaphragm at a particular level are classified as irregularities since they may cause a change in the distribution of horizontal earthquake forces to the vertical components and create torsional forces not accounted for in the normal distribution considered for a regular structure.
- (d) Where there are discontinuities in the horizontal force resistance path, the structure can no longer be considered regular. The most critical of the discontinuities to be considered is the out-of-plane offset of vertical elements of the horizontal earthquake force resisting elements. Such offsets impose vertical and horizontal load effects on horizontal elements that are, at the least, difficult to provide for adequately.

- (e) Where vertical elements of the horizontal force resisting system are not parallel to, or symmetrical with respect to, major orthogonal axes, the static horizontal force procedures cannot be applied as given and, thus, the structure should be considered to be irregular.

There is a type of distribution of vertical force resisting components that, while not being classified as irregular, does not perform well in strong earthquakes. This arrangement is a core-type building with the vertical components of the horizontal earthquake resisting system concentrated near the centre of the structure. Better performance has been observed when the vertical components are distributed near the perimeter of the structure.

**A2.3 Vertical configuration** Vertical configuration irregularities affect the responses at the various levels and induce loads at these levels that are significantly different from the distribution assumed in the static analysis described in Section 6. Examples of vertical irregularities are shown in Figure A2 and specified as follows:

- (a) A moment-resisting frame structure might be classified as having a vertical irregularity if one storey were much taller than the adjoining storeys and the resulting decrease in stiffness that would normally occur was not, or could not be, compensated for (see Figure A2(a)).
- (b) A structure would be classified as irregular if the ratio of mass to stiffness in adjoining storeys differs significantly. This might occur when a heavy mass, such as a swimming pool, is placed at one level (see Figure A2(b)).
- (c) Vertical irregularity is also created by unsymmetrical geometry with respect to the vertical axis of the structure (see Figure A2(c)). The structure also would be considered irregular if the smaller dimension were below the larger dimension, thereby creating an inverted pyramid effect.
- (d) The structure may have a geometry that is symmetrical about the vertical axis and still be classified as irregular because of significant horizontal offsets in the vertical elements of the horizontal force resisting system at one or more levels.
- (e) The problem of concentration of energy demand in the resisting elements in a storey as a result of abrupt changes in strength capacity between storeys has been noted in past earthquakes.

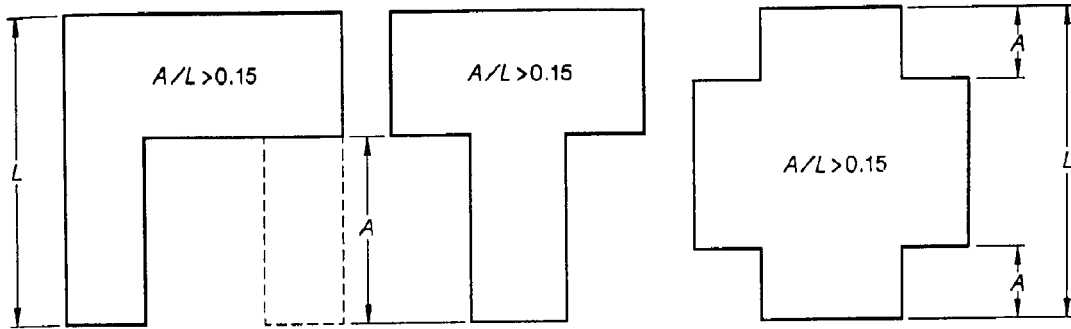

(a) Geometry

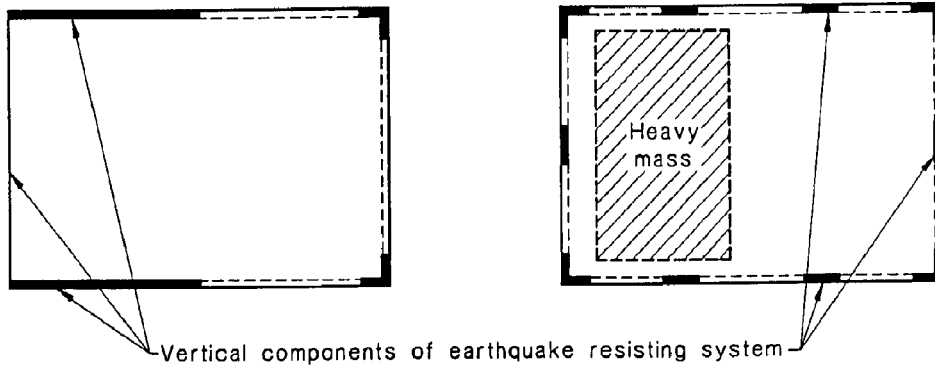

(b) Mass resistance eccentricity

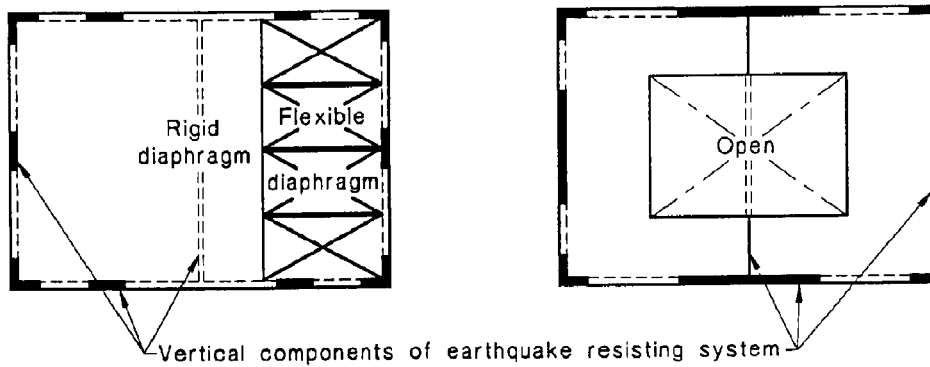

(c) Discontinuity in diaphragm stiffness

FIGURE A1 STRUCTURE PLAN IRREGULARITIES



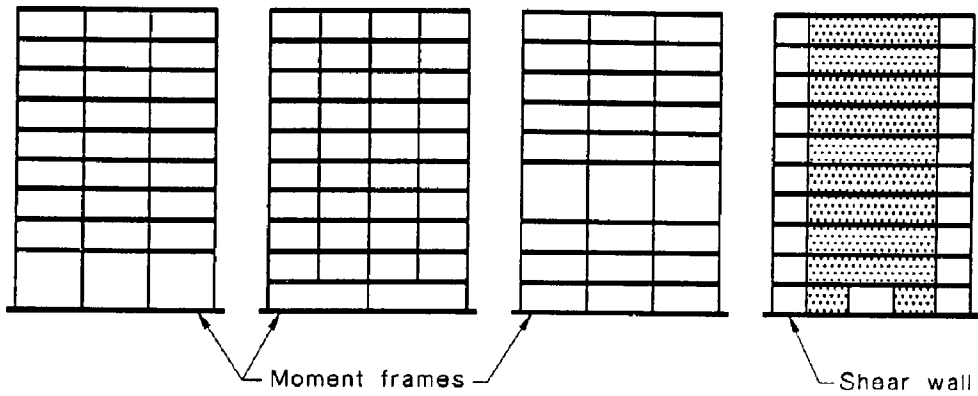

(a) Stiffness ratio

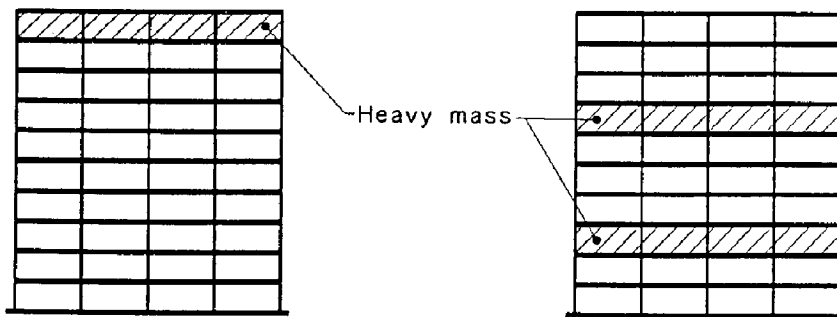

(b) Mass ratio

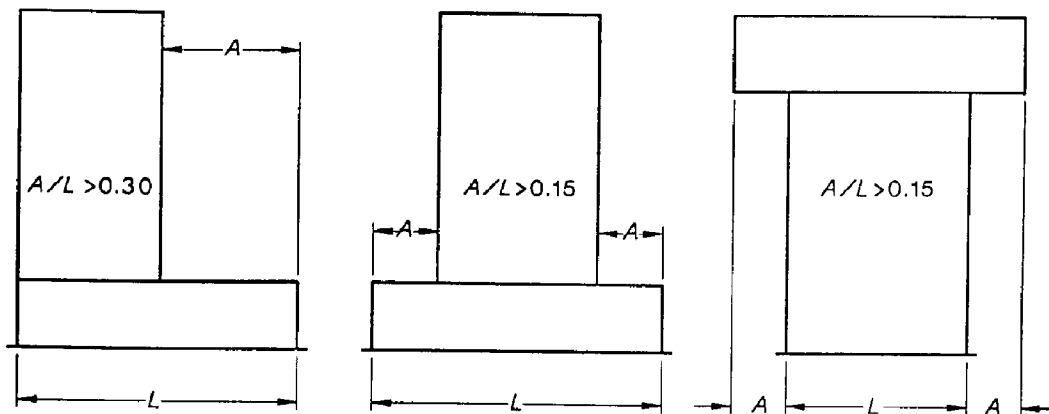

(c) Geometry

FIGURE A2 STRUCTURE VERTICAL IRREGULARITIES

APPENDIX B  
STRUCTURAL SYSTEM  
(Informative)

**B1 DUCTILITY** Structures in which members and their connections can sustain a number of load reversing post-yield deflection cycles whilst maintaining a substantial proportion of their initial load-carrying capacity are defined as ductile structures. Ductility or ductility ratio is often used as a measure of this attribute. The ductility of a member or structure is typically defined as the ratio of the deformation at failure to the deformation at yield.

Some forms of construction, such as moment resisting frames, can be expected to exhibit considerable ductility, while others are limited in their capacity for ductile behaviour. The structural response factors ( $R_f$ ) given in Tables 6.2.6(a) and 6.2.6(b) reflect the levels of ductility assessed for each structural system.

Elements with no or limited ductility should be considered non-ductile. Unreinforced masonry is considered to be non-ductile. Examples of ductile and non-ductile structures are given in Paragraph C2.

NOTE: The  $R_f$  factor as given in Tables 6.2.6(a) and 6.2.6(b) is not a displacement ductility ratio, rather it defines the level of force reduction available for a given system compared with an elastic system.

**B2 STRUCTURAL SYSTEMS** To design for earthquake loads, a structure should be classified into one of four earthquake resisting systems: bearing wall system, building frame system, moment resisting frame system, and dual system.

For the moment resisting frame system, three levels of ductility of the moment resisting frames are recognized: ordinary, intermediate and special. The special ductility level is not expected to be necessary for most design in Australia but has been included if required in special circumstances. The design and detailing requirements for each level of ductility will be provided in the appropriate material Standards. The following is a broad outline of these requirements:

- (a) For concrete structures: ordinary moment resisting frames (OMRFs) are those designed in accordance with [AS 3600](#), excluding Appendix A of that Standard. Intermediate moment resisting frames (IMRFs) are those designed in accordance with [AS 3600](#), including Appendix A of that Standard. Special moment resisting frames (SMRFs) are those designed similar to the earthquake requirements of ACI.318-92.

NOTE: Appendix A of [AS 3600](#) is being revised to conform with this Standard.

- (b) For steel structures: Ordinary moment resisting frames (OMRFs) are those designed in accordance with [AS 4100](#), excluding Section 13 of that Standard. Intermediate moment resisting frames (IMRFs) are those designed in accordance with [AS 4100](#) and satisfy all the requirements of Section 13 of that Standard. Special moment resisting frames (SMRFs) are those designed similar to the earthquake requirements of UBC 1991.

NOTE: Section 13 of [AS 4100](#) is being revised to conform with this Standard.

- (c) Other materials including masonry and timber.

NOTE: The other material Standards will be revised to conform with this Standard in regard to earthquake resistance.

## APPENDIX C

### DOMESTIC STRUCTURES

(Informative)

**C1 GENERAL** This Appendix gives further guidance on ways of improving horizontal earthquake resistance of domestic structures. In general, a system designed to resist horizontal wind loads for ductile structures such as timber or steel framed structures is adequate to resist horizontal earthquake loads. However, it should be noted that while the total resistance required for earthquake loads is the same for each of the two axes that are to be considered, the total resistance for wind loads is different for the two axes (except for square structures). Furthermore, the strength requirements for earthquake resistance is a function of the ductility of the system.

The following guidance is based on New Zealand Standard NZS 3604:1990 Code of Practice for Light Timber Frame Buildings not requiring specific design.

All ties should be designed for horizontal earthquake forces in either direction. Connection details for timber structures of earthquake Design Categories H1 and H2 should comply with [AS 1684](#).

For domestic structures of earthquake Design Category H3, plan shapes which are relatively regular are preferred and open channel-shaped plans, use of picture windows, large sliding doors, etc should be avoided.

The Standard does not make recommendations for domestic structures which fall outside these guidelines.

### C2 TYPE OF STRUCTURES

**C2.1 Ductile structures** The following structures are considered ductile based on the history of performance of such structures under earthquake loads:

- (a) Reinforced and prestressed concrete structures.
- (b) Steel frame structures including masonry veneer.
- (c) Timber frame structures including masonry veneer.
- (d) Reinforced masonry structures.
- (e) Other systems that can be shown to be ductile.

**C2.2 Non-ductile structures** The following structures are considered non-ductile based on the history of performance of such structures under earthquake loads:

- (a) Unreinforced masonry.
- (b) Pise or mud brick.
- (c) Other systems that can be shown to be non-ductile.

NOTE: Paragraphs C2.1 and C2.2 apply to domestic structures and general structures.

### C3 DETAILING GUIDES

**C3.1 Foundation and subfloor framing** Subfloor braces of either diagonal or sheet form should be provided for discrete footings except for cantilevered pier footing with clearance less than 500 mm where the piers are encased and embedded in concrete for a minimum of 450 mm depth in general and 900 mm depth for corner piers.

The upper end of a diagonal subfloor brace should be attached to a brace pier, a bearer or a joist. The lower end of the brace should not be higher than 150 mm above the finished ground level.

**C3.2 Wall framing** Wall bracing elements may be placed on external and internal walls on bracing lines. They should be located as far as practicable at the corners of the external walls and evenly distributed throughout the structure.

**C3.3 Roof bracing** Roof plane diagonal brace should be provided for roofs with gable end.

**C3.4 Tiled roofs** Tiled roofs should have diagonal bracing fully tied to walls and gable ends so that the roof is fully braced. For freestanding carports and the like with tiled roofs, consideration should be given to restrain such roofs.

**C3.5 Gable ends and parapets** Gable ends and parapets of earthquake Design Categories H1, H2 and H3 should be tied to the roof.

APPENDIX D  
TYPES OF DYNAMIC ANALYSIS  
(Informative)

**D1 EARTHQUAKE ACTIONS** The response spectra shown in Figure 7.2 are plots of the ratio of the earthquake design coefficient ( $C$ ) divided by the acceleration coefficient ( $a$ ) multiplied by the site factor ( $S$ ) for each of the five values of  $S$  given in Table 2.4(a). The spectra have been developed assuming 5% structural damping. The curves can be expressed mathematically as follows:

$$\frac{CS}{a} = \frac{1.25S}{T^{2\beta}} \leq 2.5 \quad \dots D1$$

where

$T$  = structure period

In order for the spectra shown in Figure 7.2 to be consistent with the static analysis in Section 6, the spectra should be multiplied by the appropriate importance factor ( $I$ ) and acceleration coefficient ( $a$ ), and divided by the appropriate structural response factor ( $R_f$ ) (see Tables 2.5, 2.3, 6.2.6(a) and 6.2.6(b) respectively).

Specific site response spectra may be developed for design in lieu of the response spectra shown in Figure 7.2. This requires detailed information about the geological conditions, tectonic conditions, earthquake recurrence and foundation material properties for the specific site. This information may be obtained from a number of sources such as earthquake engineers, seismologists and geotechnical engineers.

Ground motion time histories may be chosen for a specific site, however, they should be representative of actual earthquake motions and the response spectra from the time histories should approximate the site design spectrum specified in Clause 7.2(a). It will normally be necessary to use more than one time history to produce a response spectrum approximating the site design spectrum. The response spectra corresponding to specific site ground motion time histories should be ‘smoothed’ and ‘normalized’ to the effective peak ground acceleration for the record before comparing to the response spectra in Figure 7.2. For details regarding the calculation of effective peak ground acceleration from response spectra, see Tentative Provisions for the Development of Seismic Regulations for Buildings, *Applied Technology Council*, ATC-3-06(1988), 2nd ed., Palo Alto, USA.

**D2 RESPONSE SPECTRUM ANALYSIS**

**D2.1 General** For more information regarding the response spectrum method of analysis, see—

- (a) CLOUGH, R.W. and PENZIEN, J., *Dynamics of Structures*, New York: McGraw-Hill, 1975;
- (b) CHOPRA, A.K., *Dynamics of Structures, A Primer*, Berkeley: *Earthquake Engineering Research Institute*, 1980; or
- (c) BIGGS, J.M., *Introduction to Structural Dynamics*, McGraw-Hill.

**D2.2 Number of modes** All significant modes may be considered to be included in the calculation of the response for each principal direction if the participating mass amounts to at least 90% of the total mass of the structure.

**D2.3 Combining modes** The ‘square root of the sum of the square’ (SRSS) method of combination is widely used when the modal periods are well separated while the ‘absolute sum’ method is sometimes used for cases with closely-spaced modal periods. When three dimensional models are used for analysis, modal interaction effects should be considered when combining modal maxima. One combination method which accounts for modal interaction is the ‘complete quadratic combination’ (CQC) method. For more information regarding combination methods, see *Seismic Analysis by Computer, The Electronic Computation Committee of the Structural Engineers Association of Southern California, SEAOSC, 1977, 2550 Beverly Blvd. CA, 90057.*

**D3 TIME HISTORY ANALYSIS** The time history method of analysis may be used to calculate the response of a structure at each increment of time when the base of the structure is subject to a specific ground motion time history. This method has the advantage over the linear-elastic response spectrum method in that it may be used to analyze the response of highly non-linear structures. It has the disadvantage that it generally requires more computing effort and memory and most designers are usually only interested in the maximum structural response, not necessarily the response at each time increment. The ground-motion time histories used should be appropriate for the specific site and have response spectra which approximate the appropriate design spectrum in Figure 7.2. For more information on this method of analysis, see—

- (a) CLOUGH, R.W. and PENZIEN, J., *Dynamics of Structures*, New York: McGraw-Hill, 1975;
- (b) CHOPRA, A.K., *Dynamics of Structures, A Primer*, Berkeley: *Earthquake Engineering Research Institute*, 1980; or
- (c) BIGGS, J.M., *Introduction to Structural Dynamics*, McGraw-Hill.

## APPENDIX E STRUCTURAL ALTERATIONS

(Informative)

**E1 INTRODUCTION** This Appendix is included for guidance and information. It is not intended that unsuitable or indiscriminate alterations be carried out which significantly reduce the structural integrity of structures to resist earthquake loads, particularly for non-ductile structures, such as unreinforced masonry structures.

This Appendix applies to existing structures where renovation, alterations, additions or repairs are carried out which significantly reduce the strength of the structure to resist horizontal earthquake forces and strengthening of the structure as required by regulatory authorities.

It is also recognized that it may not be possible to show that an existing structure can withstand the horizontal forces acting on it as a whole. It is not intended that these measures should result in a disproportionate expenditure to achieve strengthening.

Therefore strengthening of existing structures, where required due to structural alterations, should be as follows:

- (a) *Structures with no or poor horizontal load capacity including loadbearing masonry structures* Secure the structure as a whole to develop its inherent strength with attention to local strengthening and tying together.
- (b) *Structures with limited horizontal load capacity* Strengthen the structure by introduction of moment resisting frames, braced frames, shear walls or the like, to develop the full inherent strength of the existing structure including local strengthening and tying together.
- (c) *Structures with horizontal load capacity including moment resisting frames, braced frames or shear walls* Secure attachments and strengthen local parts only to comply with Section 5 to develop the full inherent strength of the existing structure.
- (d) *Additional storey or the like* The whole structure as altered, including all new works to comply with this Standard.
- (e) *Type III structures* Structures with post-disaster functions, or hazardous facility structures to be strengthened fully by moment resisting frames, braced frames, shear walls or the like, including systems and components, to resist the horizontal earthquake forces in accordance with this Standard.

**E2 DESIGN** Items to be considered when the structure is required to be strengthened should include the following:

- (a) Parapets, gables, chimneys, tower-like appendages and the like.
- (b) Long and high walls (particularly unreinforced masonry) with limited or no horizontal support.
- (c) Wall connection to roof and floors.
- (d) The effectiveness of roofs and floors to act as horizontal diaphragms, especially with framed construction and tiled roofs.
- (e) Unbonded corners, weak mortar, corroded masonry ties and the like.
- (f) Removal, or securing of heavy objects, ornamentation, gargoyles and the like.
- (g) Support systems for heavy concrete or timber floors.
- (h) Removal of excess load from overloaded floors.

- (i) Strengthening of areas damaged in previous earthquakes or by structural movements.
- (j) Strengthening of the structure where significant lack of symmetry, strength or irregularity occurs, e.g. extensive glass facades or openings, particularly where present in the lower storeys.
- (k) Fastening of inadequately secured fire escape access and egress.
- (l) Fastening of inadequately secured heavy equipment including light fittings, mechanical, electrical and lift equipment.
- (m) Compactus and storage equipment.
- (n) Deterioration of the structure including variable strengths of existing materials.
- (o) Effects on adjacent structures.
- (p) Verandahs supported by walls and the like.
- (q) Other items as required by regulatory authorities.

### **E3 ARCHITECTURAL, MECHANICAL AND ELECTRICAL COMPONENTS**

Components should be secured and should be part of any strengthening to an existing structure.