



PENN BARRY

AMCA Standards On Fan Arrangements, Rotation, Discharge & Motor Position

Data contained in this issue should be thoroughly understood, as it is important in properly choosing, applying, pricing and ordering centrifugal and axial fans of all types. The terminology contained is a standard with the Air Movement and Control Association (AMCA) and has been adapted by the industry as a whole. It should be a part of your everyday language when considering fans.

Drive Arrangements

AMCA Standards 99-2404-03, 99-2410-03 (see pages 2, 3 and 7). These pages illustrate the usual fan arrangements with their proper numbers. When ordering fans, or when requesting data or prices, the required fan arrangement MUST always be indicated.

Inlet Box Positions For Centrifugal Fans

Standard 99-2405-03 (see page 4 and 8). This page shows proper designations for inlet box positions, in degrees. When ordering fans with inlet boxes this information is required.

Designations For Rotation & Discharge Of Centrifugal Fans

AMCA Standard 99-2406-03 (see page 5). Proper terminology is clearly indicated on this page. When ordering equipment, or when requesting certified prints, always be sure to include this information. No order will begin fabrication without it, if in doubt as to proper designation, draw a sketch. In the event that an angular discharge is required that is NOT at 45°, be sure to clearly state what is required, such as "top angular down 30° from horizontal" or "bottom angular up 20° from horizontal." Here again, draw a sketch if in doubt.

Motor Positions For Belt Drive Centrifugal Fans

AMCA Standard 99-2407-03 (see page 6). This page indicates standard nomenclature for properly locating the motor in reference to the drive side of the fan. It is fully accepted by the industry and vibration base manufacturers as well. If a bare fan without motor or drive is ordered this information is not needed; but whenever a drive or vibration base is to be included this information is absolutely necessary. Please note that motor position is always determined from the drive side of the fan, and has no reference whatsoever to fan rotation or discharge.

Drive Arrangements For Centrifugal Fans AMCA Standard 99-2404-03

NOTES:

SW - Single Width **DW** - Double Width

SI - Single Inlet **DI** - Double Inlet

Arrangements 1, 3, 7 and 8 are also available with bearings mounted on pedestals or base set independent of the fan housing.

For designation of rotation and discharge, see page 5.

For motor position, belt or chain drive, see page 6.

For designation of position of inlet boxes, see page 4.

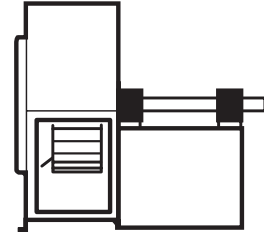

ARR. 1 SWSI - For belt drive or direct connection. Impeller overhung. Two bearings on base.

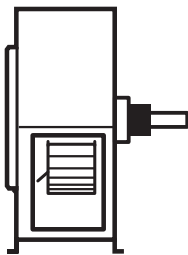

ARR. 2 SWSI - For belt drive or direct connection. Impeller overhung. Bearings in bracket supported by fan housing.

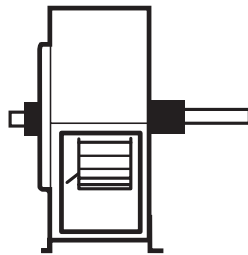

ARR. 3 SWSI - For belt drive or direct connection. One bearing on each side and supported by fan housing.

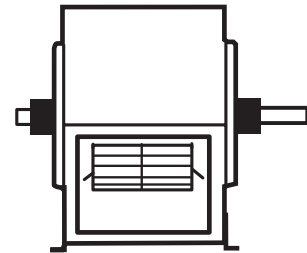

ARR. 3 DWDI - For belt drive or direct connection. One bearing on each side and supported by fan housing.

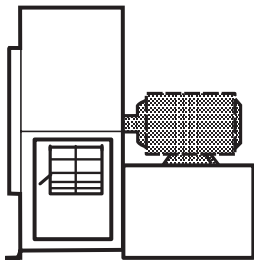

ARR. 4 SWSI - For direct drive. Impeller overhung on prime mover shaft. No bearings on fan. Prime mover base mounted or integrally directly connected.

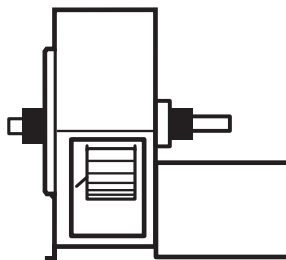

ARR. 7 SWSI - For belt drive or direct connection. Arrangement 3 plus base for prime mover.

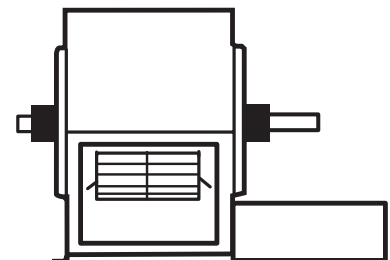

ARR. 7 DWDI - For belt drive or direct connection. Arrangement 3 plus base for prime mover.

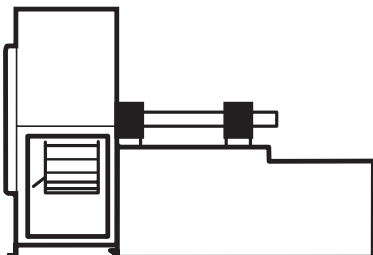

ARR. 8 SWSI - For belt drive or direct connection. Arrangement 1 plus extended base for prime mover.

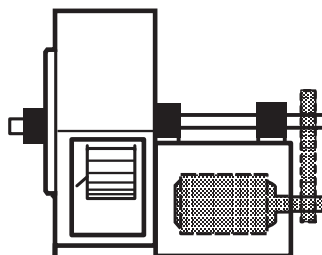

ARR. 9 SWSI - For belt drive. Impeller overhung, two bearings, with prime mover outside base.

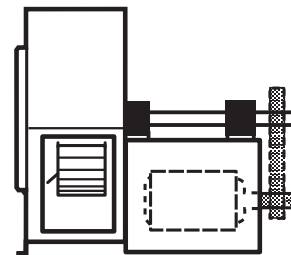

ARR. 10 SWSI - For belt drive. Impeller overhung, two bearings, with prime mover inside base.

Drive Arrangements For Centrifugal Fans AMCA Standard 99-2404-03

NOTES:

SW - Single Width **DW** - Double Width

SI - Single Inlet **DI** - Double Inlet

For designation of rotation and discharge, see page 5.

For motor position, belt or chain drive, see page 6.

For designation of position of inlet boxes, see page 4.

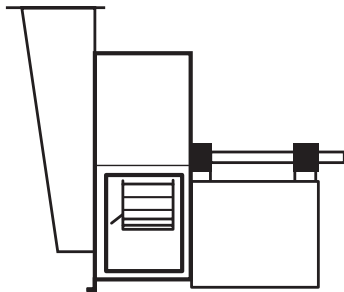

ARR. 1 SWSI With Inlet Box - For belt drive or direct connection. Impeller overhung, two bearings on base. Inlet box may be self-supporting.

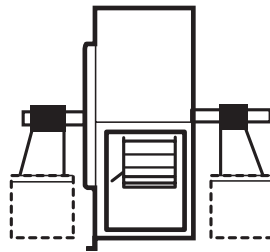

ARR. 3 SWSI With Independent Pedestal - For belt drive or direct connection fan. Housing is self-supporting. One bearing on each side supported by independent pedestals.

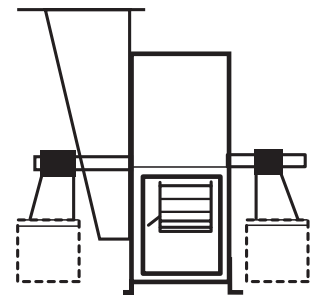

ARR. 3 SWSI With Inlet Box and Independent Pedestals - For belt drive or direct connection fan. Housing is self-supporting. One bearing on each side supported by independent pedestals with shaft extending through inlet box.

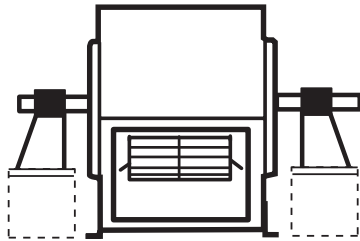

ARR. 3 DWDI With Independent Pedestal - For belt drive or direct connection fan. Housing is self-supporting. One bearing on each side supported by independent pedestals.

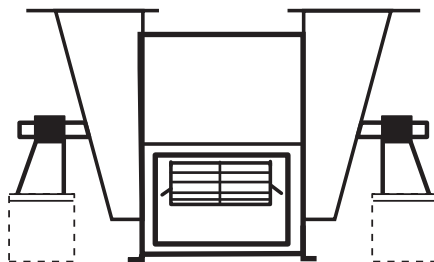

ARR. 3 DWDI With Inlet Box and Independent Pedestals - For belt drive or direct connection fan. Housing is self-supporting. One bearing on each side supported by independent pedestals with shaft extending through inlet box.

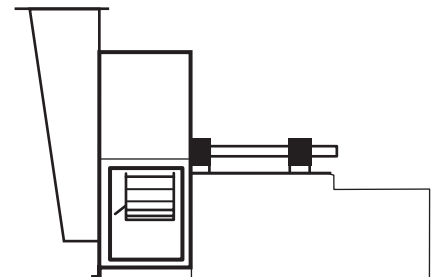

ARR. 8 SWSI With Inlet Box - For belt drive or direct connection. Impeller overhung, two bearings on base plus extended base for prime mover. Inlet box may be self-supporting.

Inlet Box Positions For Centrifugal Fans AMCA Standard 99-2405-83

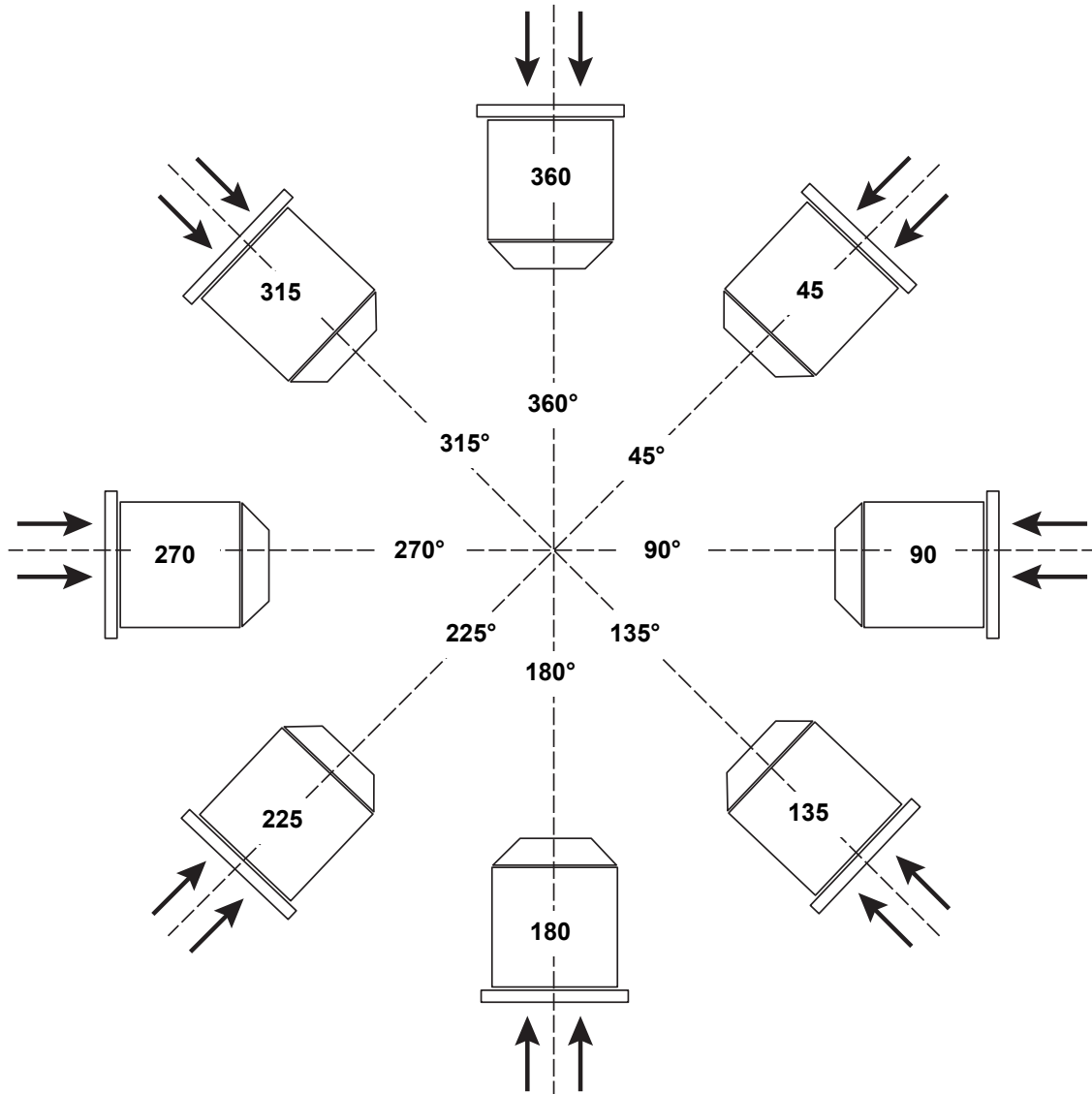

NOTES:

1. Reference line is the top vertical axis through center of fan shaft.
2. Position of inlet box and air entry to inlet box is determined from DRIVE SIDE OF FAN.
3. Position on inlet box is designated in degrees clockwise from top vertical axis as shown, and may be any intermediate angle as required.
4. Positions 135° to 225° in some cases interfere with floor structure.

Designations For Rotation & Discharge Of Centrifugal Fans AMCA Standard 99-2406-03

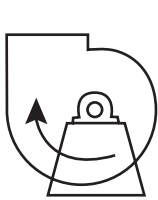

Clockwise
Up Blast
CW 360

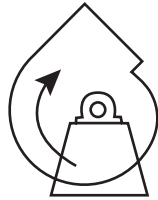

Clockwise
Top Angular Up
CW45

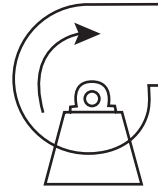

Clockwise
Top Horizontal
CW90

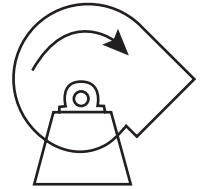

Clockwise
Top Angular Down
CW45



Clockwise
Down Blast
CW 180

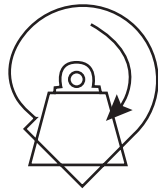

Clockwise
Bottom Angular Up
CW225

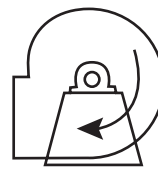

Clockwise
Bottom Horizontal
CW270

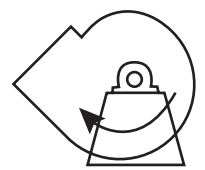

Clockwise
Bottom Angular Up
CW315



Counterclockwise
Up Blast
CW 360

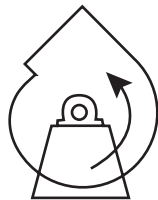

Counterclockwise
Top Angular Up
CW45

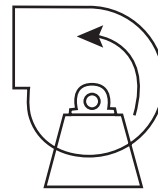

Counterclockwise
Top Horizontal
CW90

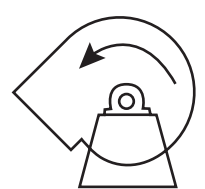

Counterclockwise
Top Angular Down
CW135



Counterclockwise
Down Blast
CW 180



Counterclockwise
Bottom Angular Down
CW225



Counterclockwise
Bottom Horizontal
CW270

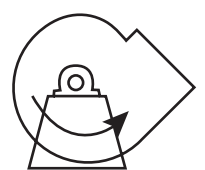

Counterclockwise
Bottom Angular Up
CW315

NOTES:

1. Direction of rotation is determined from drive side of fan (see Note 2 and 3).
2. On single inlet fans, drive side is always considered as the side opposite fan inlet (even when driven through fan inlet).
3. On double inlet fans with drives on both sides, drive side is that with the higher powered drive unit.
4. Direction of discharge is determined in accordance with diagrams. Angle of discharge is referred to the vertical axis of fan and designated in degrees from such standard reference axis. Angle of discharge may be any intermediate angle as required.
5. For fan inverted for ceiling suspension, or side wall mounting, direction of rotation and discharge is determined when fan is resting on floor.

Motor Positions For Belt Or Chain Drive Centrifugal Fans AMCA Standard 99-2407-03

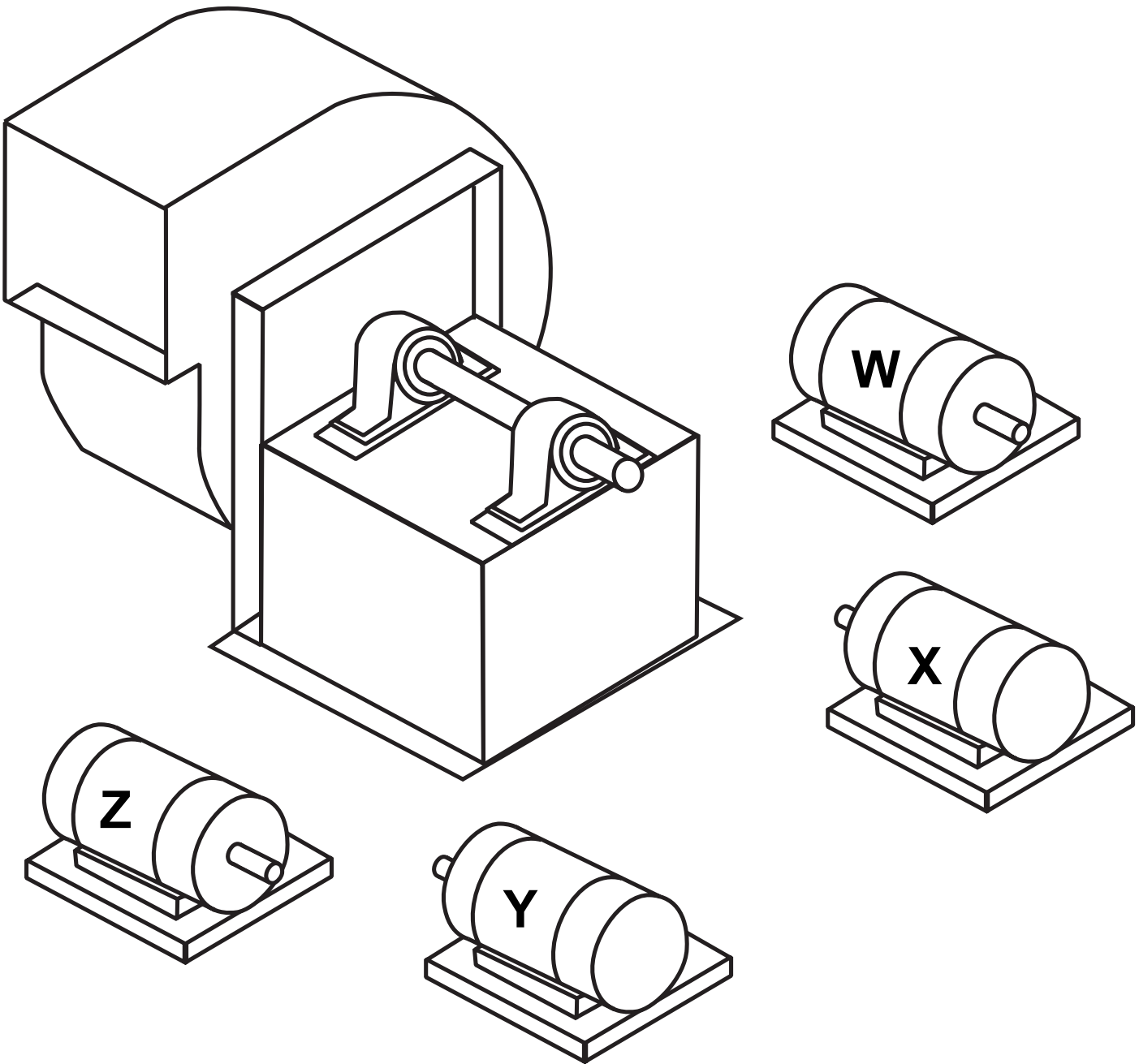
**NOTE:**

Location of motor is determined by facing the drive side of fan and designating the motor positions by letters W, X, Y or Z as the case may be.

Drive Arrangements For Tubular Centrifugal Fans AMCA Standard 99-2410-03

ARRANGEMENT 1

For belt drive. Impeller overhung on a shaft supported by bearings mounted within casing. Motor mounted independent of casing. horizontal discharge.

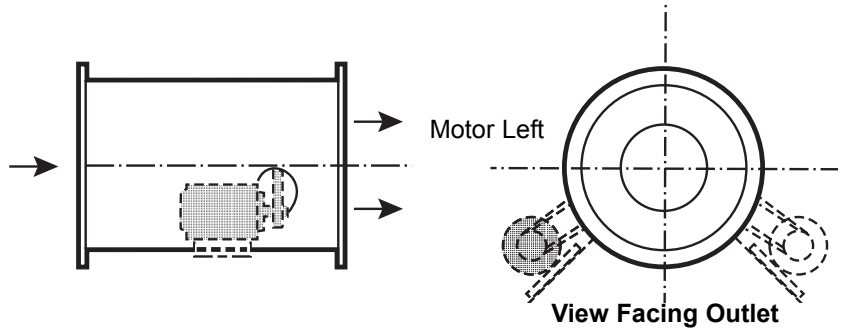

ARRANGEMENT 4

For direct drive. Impeller overhung on motor shaft. Motor supported within casing. For horizontal and vertical discharge. Duct mounting shown.

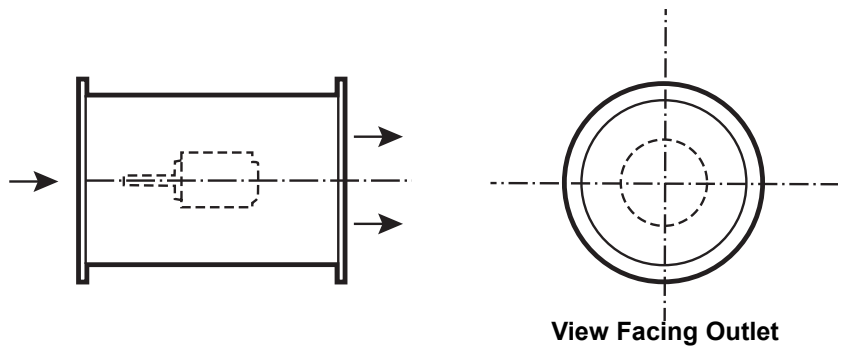

ARRANGEMENT 9

For belt drive. Impeller overhung on a shaft supported by bearings mounted within casing. Designed for mounting of motor on outside of casing in one of the standard locations shown. For horizontal and vertical discharge. Duct mounting shown.

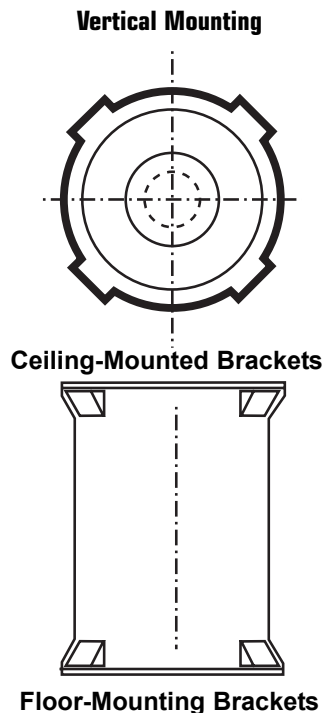
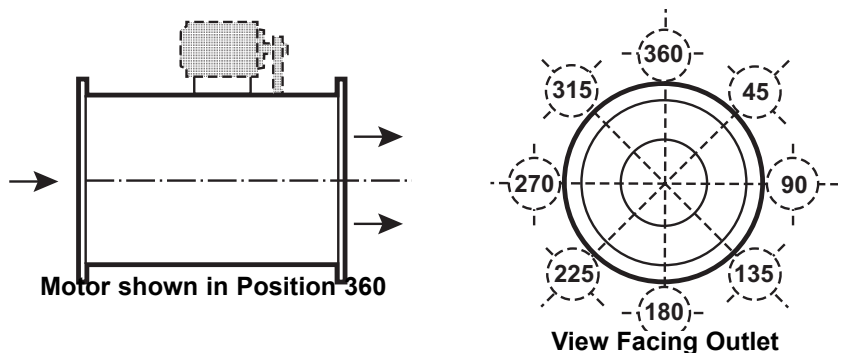

The Arrow shown above designates the direction of airflow.

Rotation of fans is determined by viewing from the fan outlet end.

Specify either up blast or down blast discharge for vertically-mounted fans.

The locations of motors, supports, access doors, etc., are determined by viewing the outlet of the fan and resting location 180 on the floor as shown for Arrangement 9.

Arrangements 4 and 9 can be furnished with supports for floor, wall or ceiling mounting. The position of these supports determines which motor locations are available for motor placement. Generally motor locations 135, 180 and 225 are not available on floor, wall or inverted ceiling-mounted fans and motor locations 45, 90, 270 and 315 may not be available for ceiling-hung fans.

Another method of mounting vertical fans as shown in the view on the right. Specify fan to be furnished with ceiling-mounting brackets, floor-mounting brackets or both.

Inlet Box Positions For Centrifugal Fans
AMCA Standard 99-2405-03

NOTE: All fan orientations may be horizontal or vertical.

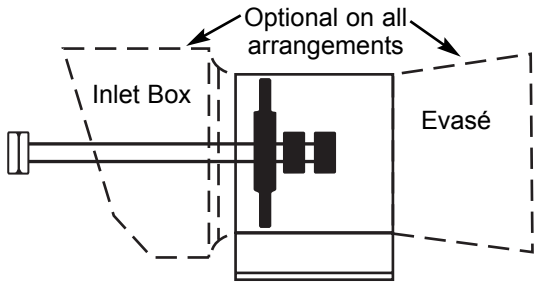

Arrangement 1

For belt drive or direct connection. Impeller overhung.
 Two bearings located either upstream or downstream of impeller.

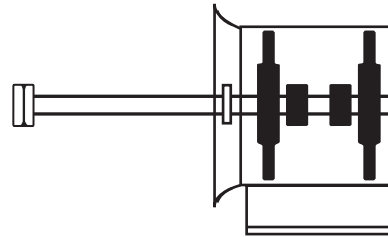

Arrangement 1 / 2-Stage

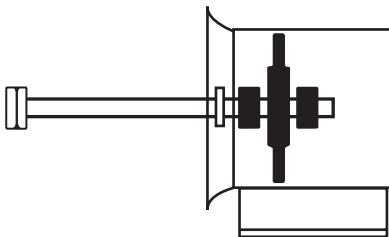

Arrangement 3

For belt drive or direct connection. Impeller between bearings that are on integral supports.
 Drive through inlet.

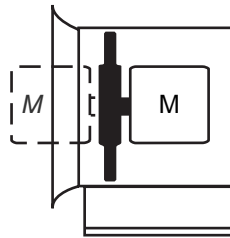

Arrangement 4

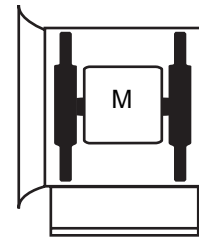

Arrangement 4 / 2-Stage

For direct connection. Impeller overhung on motor shaft.
 No bearings on fan. Motor on internal supports.

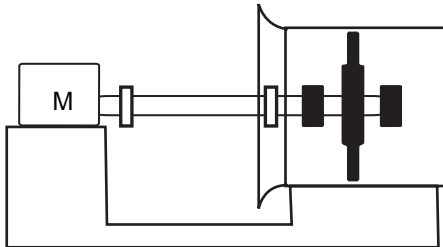

Arrangement 7

For belt drive or direct connection. Impeller between bearings that are on integral supports.
 Drive through inlet.

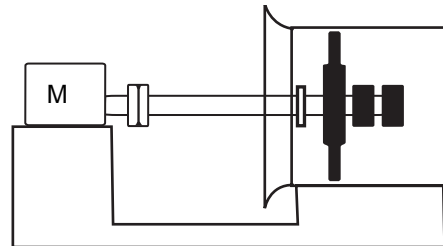

Arrangement 8 (1 or 2-Stage)

For direct connection. Impeller overhung on motor shaft.
 No bearings on fan. Motor on internal supports.

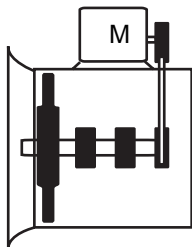

Arrangement 9 / Motor on Casing

For belt drive. Two bearings on internal supports.
 Motor on casing or on integral base. Drive through belt fairing.

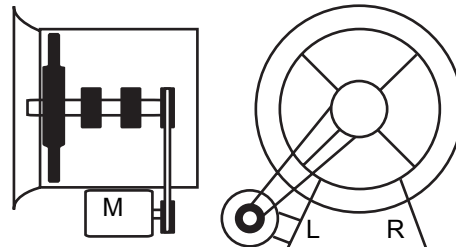

Arrangement 9 / Motor on Integral Base